



# More Precision.

Sensor systems for testing LEDs and self-luminous objects

Color | Intensity | Function | Light spectrum

LEDs and Illumination



# Sensor systems for testing LEDs and self-luminous objects

## LED tests of function, color and intensity

Micro-Epsilon offers a powerful portfolio for rapid LED tests with laboratory accuracy. The different systems cover a wide range of applications for LED tests. These measuring systems are used for parallel and automatic tests of color, function and intensity of LEDs, displays, dashboard illumination and other self-luminous objects.

The MFA-7 LED Analyzer is one of the systems. Its large number of measurement channels enables for 28 LEDs to be detected and tested simultaneously. Therefore, automated quality inspection in the production process of so-called dynamic turn signals is carried out at high frequency.

### colorCONTROL MFA

#### Flexible color recognition of up to 28 detection points for external evaluations

The MFA-7 is a high-precision, dynamic multipoint color detection system. It enables the connection of 4 x 7 measuring points and can therefore measure and monitor up to 28 test specimens simultaneously. Each measuring position is freely configurable in terms of color, intensity and function. Color inspection takes place in the XYZ, xyY, Luv, uvL or RGB color spaces. In addition, the MFA-7 outputs the dominant wavelength  $\lambda_{\text{dom}}$  and the color temperature CCT. Therefore, the MFA-7 is a suitable data supplier. Various MFS receiver sensors can be universally coupled and exchanged via fiber optics.



MFA

### colorSENSOR CFO

#### Smart color sensor system with internal evaluation of up to 254 color groups

The smart colorSENSOR CFO series offers high-quality testing of the color values, intensities and functions of LEDs or lighting modules using accurate True Color chip technology. These color recognition sensors determine the XYZ values of the test object and convert this to xyY and Luv. As well as testing single LEDs, it is also possible to detect the overall impression of the light source from a larger distance. Up to 254 color values can be taught, stored and compared with the test object using this sensor. The sensors can be parameterized and the color values read out via the Ethernet or RS232 interface.



CFO

### colorCONTROL ACS7000

#### High precision system for measuring the light spectrum of a detection point with internal evaluation

The ACS7000 inline color measuring system measures color, intensity and the visible light spectrum with highest precision. Light in the wavelength range of 390 to 780 nm is spectrally detected and evaluated in increments of 2 nm. It is possible to consider the entire light spectrum or just the desired color values. The color measurement and data transmission can also be processed in real time via the integrated RS422 and EtherCAT interfaces. In addition to pure data output, the ACS7000 controller can also learn up to 15 color spectra to evaluate them internally as OK or NOK.



ACS

## General information

Page

Measuring principle & fields of application

4 - 7

Applications

8 - 9

## Messsysteme

Page

System	Series	Sensor / Controller	Channels	Repeatability	Measurement spot diameter
--------	--------	---------------------	----------	---------------	---------------------------

### System for flexible, simultaneous color recognition of up to 28 detection points for external evaluations

	<b>colorCONTROL MFS</b>	Sensor	-	-	3 ... 16 mm	10 - 11
	<b>colorCONTROL MFA-7</b>	Controller	7, 14, 21, 28	$xy < \pm 0,000025$	-	12 - 13

### Smart color sensor system with internal evaluation of up to 254 color groups

	<b>colorSENSOR CFS5</b>	Sensor	-	-	4 ... 28 mm	14 - 15
	<b>colorSENSOR CFO</b>	Controller	1	$xy < \pm 0,00025$	-	16 - 19

### High precision sensor system for measuring the light spectrum of a detection point incl. evaluation of up to 15 color spectra

	<b>colorCONTROL ACS3</b>	Sensor	-	-	5 ... 9 mm	20 - 21
	<b>colorCONTROL ACS7000</b>	Controller	1	$xy < \pm 0,00025$	-	22 - 23

## Accessories

Page

Connection cables & Accessories

24 - 26

## Options

Page

Optional accessories for colorSENSOR CFS sensors

27

# Measuring principle and fields of application colorSENSOR / colorCONTROL

MFA

## colorCONTROL MFA

### Measuring principle

In the field of LED testing, an MFA measuring system usually consists of 7, 14, 21 or 28 sensors (depending on the controller type) and a controller (evaluation unit). The emitted light of the LED, which was received by the sensor, is transmitted via the sensor cable (optical fiber) to the controller and evaluated there. The controllers have a different number of measuring channels and can also be equipped with 7, 14, 21 and 28 measuring channels or sensors.

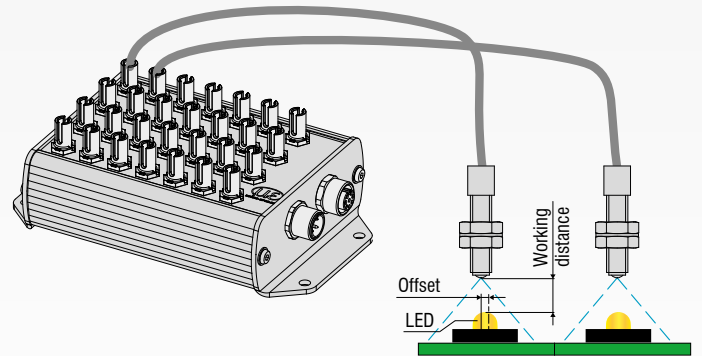

### Dominant wavelength ( $\lambda_{dom}$ ) MFA-7

A decisive advantage of the colorCONTROL MFA-7 series is the measurement of the dominant wavelength. This makes the main emission level of the white or colored light unit immediately apparent.

As the dominant wavelength cannot be derived from the spectrum, the dominant wavelength must be evaluated based on colorimetry. It results from the intersection of the straight lines defined by the white point and the measuring point. The dominant wavelength thus corresponds to the wavelength on the spectral curve of the CIE diagram where the straight line intersects the curve.

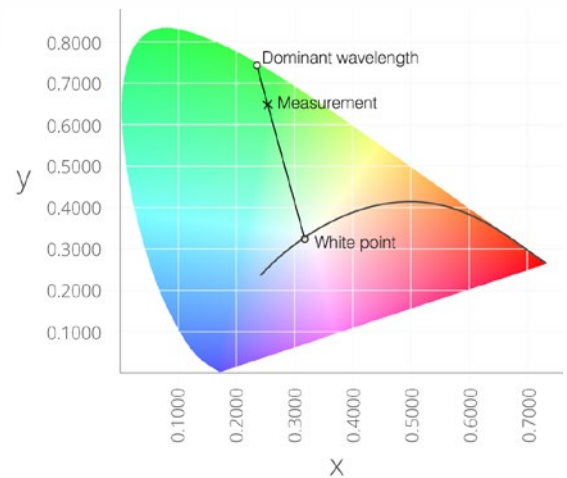

### Color temperature CCT MFA-7

The color temperature, also called light color, is a decisive feature of a lighting unit, as it makes the emitted light appear warmer or colder.

It must be set correctly on monitors, for example, to protect the eyes and to make the colors look as realistic as possible. The colorCONTROL of the MFA-7 series measures the color temperature and determines the quality of the color impression of a lighting unit. The color temperature is defined as the temperature of a black body (Planckian radiator) and is especially crucial for white lighting units/lamps.

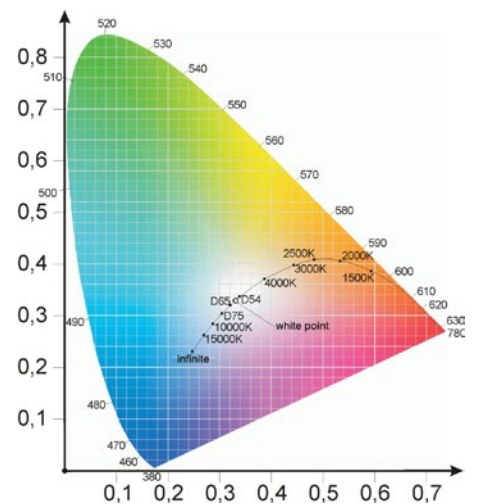

LED test sensor		Special features	
MFS-X		<ul style="list-style-type: none"> <li>- For LEDs, lamps, bulbs, headlights, backlights, displays</li> <li>- For restricted installation space</li> <li>- Accurate point-by-point testing at various points for individually arranged test items</li> <li>- Detection of smallest objects from 3 mm</li> <li>- Operating distance &gt; 3 mm</li> </ul>	
Controller	Special features	Application examples	
MFA-7		<ul style="list-style-type: none"> <li>- Multipoint color recognition system (LED)</li> <li>- High dynamic range with intensity test</li> <li>- Series with 7 detection points: MFA-7; MFA-14; MFA-21; MFA-28</li> <li>- Color inspection in XYZ, xyY, Luv- and uvL color space</li> <li>- Color distinction, intensity test &amp; functional test</li> <li>- Output of the dominant wavelength (<math>\lambda_{dom}</math>) and color temperature (CCT)</li> <li>- Integration into testing process via RS232, RS422 or USB interface</li> </ul>	<ul style="list-style-type: none"> <li>- Testing self-luminous objects</li> <li>- LED tests (binning)</li> <li>- Indicator tests</li> <li>- Display tests</li> <li>- Seven-segment display tests</li> <li>- Front panel tests</li> </ul>
MFA-14			
MFA-21			
MFA-28			

# CFO

## colorSENSOR

### Measuring principle

In the field of color inspection, a measuring system usually consists of a sensor with optical fiber and a controller (evaluation unit). The light (color) to be measured from the self-luminous sensor is received by the sensor's optical fiber and evaluated by the controller. The sensors have different measuring geometries and can optionally be extended by mountable lenses for focusing or to achieve larger measurement spots and working distances

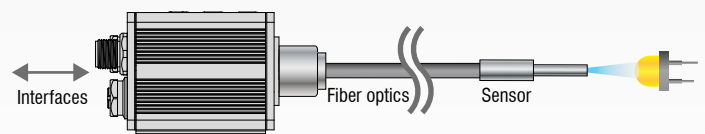

### Powerful multi-teach feature CFO100/200

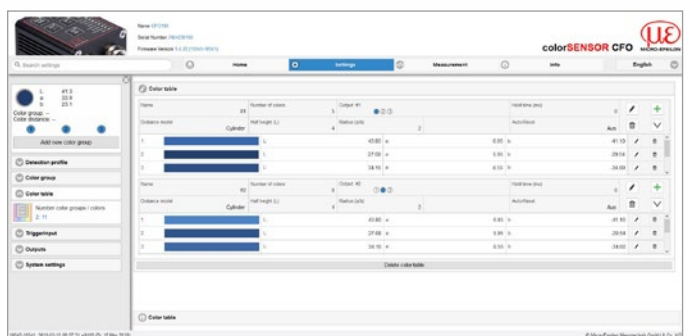

Up to 254 color groups with more than 320 individual colors can be taught in the CFO controller. The color groups are used among other things to increase color accuracy. Since the detected colors vary with different distances between sensor and measuring object, these color variants can easily be taught into a color group. Individual color groups can be created for different color shades. The color groups thus offer a decisive advantage in the case of geometry-related color deviations.



# Measuring principle and fields of application

## colorSENSOR / colorCONTROL

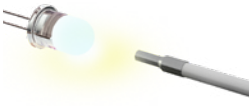
Color measuring system colorSENSOR CFO

LED test sensor	Special features	
<p>CFS5-Axx CFS5-Cxx CFS5-xx</p> 	<ul style="list-style-type: none"> <li>- Ideal for testing LED, illumination and self-luminous objects</li> <li>- For color sensor with external illumination</li> <li>- Measurement distance 30 mm</li> <li>- Detection of smallest color and intensity variations</li> <li>- For self-luminous, diffuse reflection incl. gloss</li> </ul>	
Controller	Special features	Application examples
<p><b>Universal True Color sensor controller CFO100</b></p> 	<ul style="list-style-type: none"> <li>- Color values can be read and statistically evaluated</li> <li>- Repeatability in color <math>\Delta E \leq 0.5</math></li> <li>- Measuring rate max. 10 kHz (up to 2,500 parts per second with asynchronous measurement)</li> <li>- Color memory for 256 colors in 6 color groups</li> <li>- Operation via keys or web interface</li> <li>- Ethernet and RS232 interface</li> <li>- 3 switching outputs (digital I/O); 8 switching outputs (binary)</li> <li>- Multi-teach feature</li> </ul>	<ul style="list-style-type: none"> <li>- Testing self-luminous objects</li> <li>- Inspection of backlit buttons</li> <li>- LED tests (binning)</li> <li>- Color and gray-scale detection</li> </ul>
<p><b>High precision True Color sensor controller CFO200</b></p> 	<ul style="list-style-type: none"> <li>- Color values can be read and statistically evaluated</li> <li>- Repeatability in color <math>\Delta E \leq 0.3</math></li> <li>- Measuring rate max. 30 kHz (up to 7,500 parts per second with asynchronous measurement)</li> <li>- Color memory for 320 colors in 254 color groups</li> <li>- Operation via keys or web interface</li> <li>- Ethernet, RS232 and USB interface, option with Modbus (PROFINET, EtherNet/IP, EtherCAT possible via Gateway)</li> <li>- 8 switching outputs (digital I/O); 256 switching outputs (binary)</li> <li>- Multi-teach feature</li> </ul>	

### Intuitive operation via web interface

A decisive advantage of the CFO test systems is their easy operation. Each sensor system can be entirely configured in a convenient and user-friendly web interface. The respective controller is connected to a PC via an Ethernet interface.

The web interface features measurement value display as well as set up and configuration of e.g. exposure or measuring rate. Furthermore, the sensor can be adapted to suit different color groups and tolerance spaces for each color. The web interface is not required for regular operation.

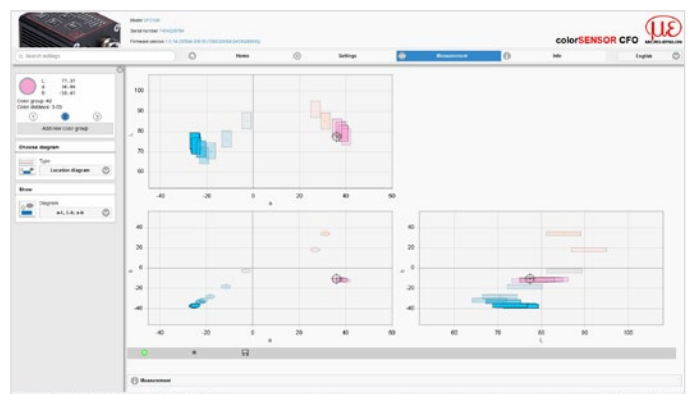

## colorCONTROL ACS

### Measuring principle

In the field of inline color measurement, an ACS measuring system usually consists of an ACS3 receiver sensor with optical fiber and the ACS7000 controller (evaluation unit). The light emitted by the self-illuminator is received by the sensor head and transmitted to the controller via the optical fiber. Subsequently, the evaluation takes place in the controller.

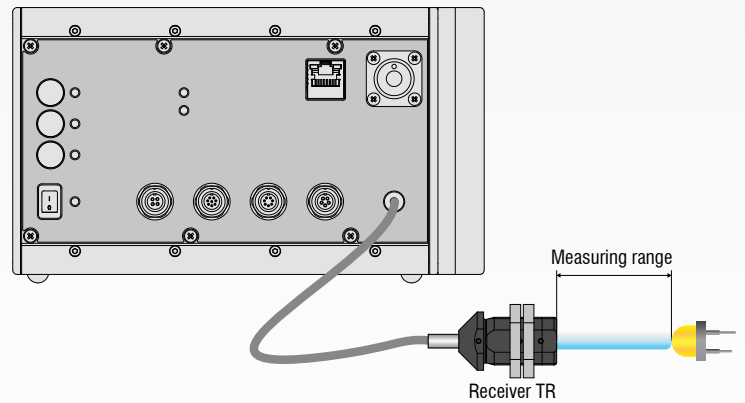



### High precision inline color measuring system ACS7000

The spectral procedure is the most accurate method of color measurement. Here, the received light spectrum is split in 2 nm increments and projected onto a line. Then the coordinates in the CIE-XYZ color system are determined for all wavelengths of visible light (390 to 780 nm) as well as calculated and output in the desired color space. The controller takes into account different observation conditions such as the type of light (illuminant) and standard observer.



Inline color measuring system colorCONTROL ACS7000

Receiver sensor	Special features	
<p>ACS3-TR</p> 	<ul style="list-style-type: none"> <li>- Measurement distance: max. 200 mm</li> <li>- Measurement spot: 3x2 / 5 / 9</li> </ul>	
Controller for inline color measurement	Special features	Application examples
<p>ACS7000</p> 	<ul style="list-style-type: none"> <li>- Spectral evaluation of light (390 to 780 nm)</li> <li>- Repeatability in color <math>\Delta E \leq 0.08</math></li> <li>- Measuring rate max. 2 kHz</li> <li>- Ethernet/EtherCAT, RS422</li> <li>- 4 switching outputs (digital I/O); 16 switching outputs (binary)</li> <li>- Ease of use via web interface</li> <li>- Color memory for 15 colors</li> </ul>	<p>Measuring the light spectrum of self-luminous objects</p>

# Applications

## colorSENSOR / colorCONTROL

### Color and intensity testing of vehicle headlights

Vehicle headlights are available with different light units. With structured glass, the various built-in lights and lamps are checked for the correct light and glass color.

For LED headlights, for example, the colorCONTROL MFA-7 checks the homogeneity and intensity directly inline without contact.

*Recommended system: MFA-21 + MFS-K04-3*

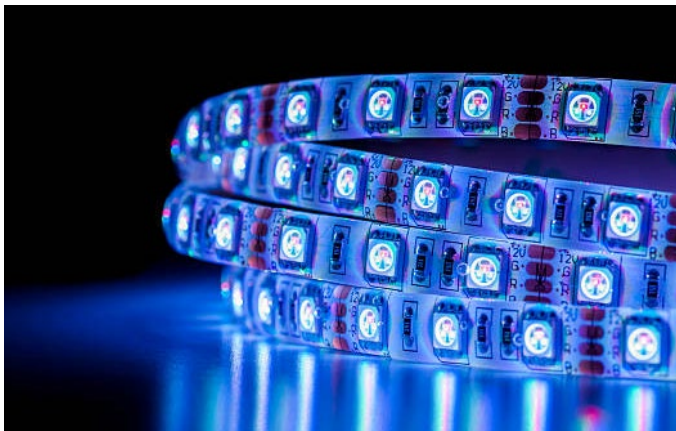

### LED testing of electronic assemblies

These days, numerous circuit boards are equipped with LEDs. As the sensors are very thin, they can check up to 28 LEDs simultaneously for luminosity and function during the functional test of the board.

The light passing through the sensors to the MFA-28 controller is reliably evaluated. Therefore, Micro-Epsilon sensor systems for LED tests save time and money in quality assurance.

*Recommended system: MFA-28 + MFS-K04-6*

### Brightness testing of LED line lights

After the production of LED strips and line lights, a 100 percent inspection of all installed LEDs is carried out in the quality assurance department.

The MFA-28 multi-point color detection system from Micro-Epsilon detects LEDs reliably thanks to its high measuring rate. If up to 5 systems are used, up to 140 LEDs can be tested simultaneously.

*Recommended system: MFA-14 + MFS-K04*

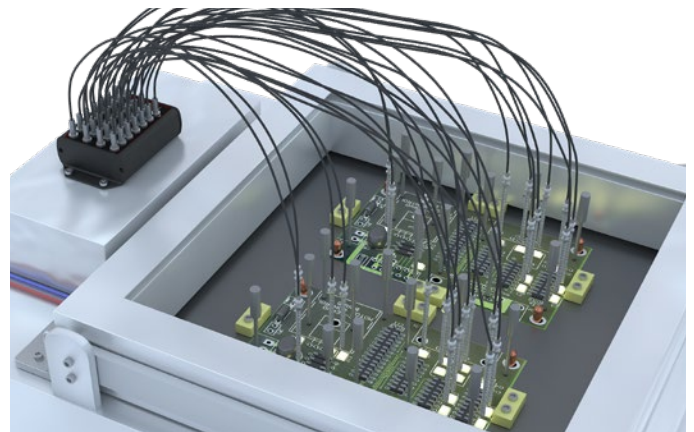

### LED backlights for control panels and operating elements

Kitchen appliances come in different designs with various lighting types. After final assembly, the multicolor LEDs are checked for function and quality using Micro-Epsilon's LED test system.

One of the greatest advantages of the multi-point color detection system is the simultaneous testing of multiple LEDs, which are located in different positions.

*Recommended system: MFA-7 + MFS-22*



### Homogeneity testing of displays and surface area lights

Modern monitors or televisions are illuminated with LED technology. In order to calibrate color, intensity and light distribution in quality assurance, LED test systems from Micro-Epsilon are used. 20 controllers of type MFA-28 with a total of 560 receiver sensors of type MFS-K04-03 check the surface area light in the line during calibration. This results in time savings with a high measuring rate and dynamic response combined with high repeatability.

*Recommended system: MFA-28 + MFS-K04-6*



**Partially transparent plastic pushbuttons for car interiors** are checked for uniformity in the transparent area to avoid deviating illumination intensity. For the measurement with the colorSENSOR CFO200 a background illumination is used. The light passing through the semi-transparent light is detected by the CFS5 and evaluated by the colorSENSOR CFO200 controller. The CFO200 measures the color differences and compares them with the target values. This is how the finest of illumination differences are detected that are barely visible to the human eye.

*Recommended system: CFO200 + CFS5*

### Color measurement of LED panels (RGB)

When RGB LED panels are produced, the challenge is to create a uniform, completely homogeneous surface. Therefore, a diffuser layer is used, which enables a regular scattering of the otherwise point-shaped LED light. In order to avoid defects in the material and during production, the inline colorCONTROL ACS7000 color measuring system is used with the ACS3-TR receiver unit. Errors can therefore be recognized during the production process itself rather than the previous method of manual final inspection, which is no longer necessary.

*Recommended system: ACS7000 + ACS3-TR*

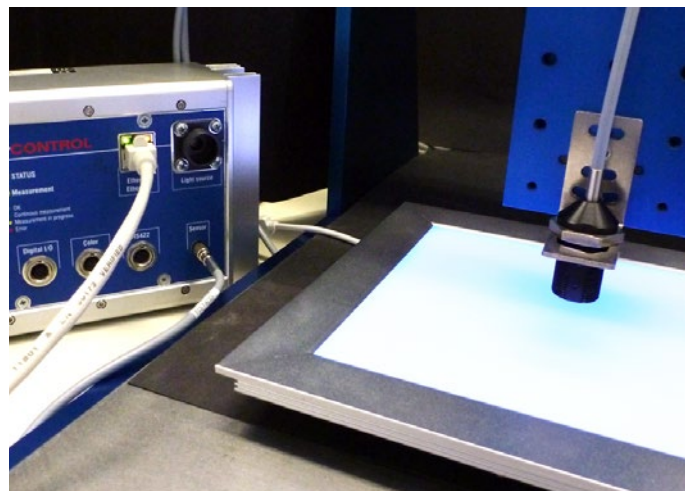



For LEDs, lamps, bulbs, headlights, backlights, displays



For restricted installation space



Accurate point-by-point testing at various points for individually arranged test items



Detection of smallest objects from 3 mm



Working distance > 3 mm



The light emitted by the luminaire under test is received by the MFS receiver sensor at 0° (parallel) to the direction of emission. The received light beams are transmitted to the controller via an optical fiber. The range of sensors offered covers a wide variety of working distances and spot sizes. Other versions in different lengths and temperature ranges are available as options.

The MFS sensor (receiver sensor) in combination with the powerful MFA controllers offers extremely precise testing of light color, intensity, color temperature (CCT) and dominant wavelength ( $\lambda_{dom}$ ). This is required, for example, when dividing LEDs into binnings, or for testing homogeneity within a light source with several individual LEDs.

In addition to their outstanding performance, the receiver sensors also impress with extremely advantageous installation options. Due to the external controller, less installation space is required at the measuring point. In addition, measuring points that are far apart can be tested together with a controller.

**MFS-I01:** Due to its extremely thin diameter of just 1.3 mm, the MFS-I01 is ideal for use in very confined installation spaces. It is perfectly suitable for SMD-LED tests. The metal sleeve on the sensor head ensures straight guidance and exact positioning above the LED.

**MFS-22:** The MFS-22 consists of a POF (polymer optical fiber) and a PVC sheath with a cut end.

**MFS-K04:** The M4 thread guidance enables easy installation, allowing more precise positioning of the sensor.

**MFS-K04-3:** Smallest measuring spot and best light collection thanks to improved coupling into the fiber.

**MFS-K04-6:** This sensor has the largest measurement spot, allowing more variable positioning of the test specimens under the sensor. In addition, measurements can be made on a larger illuminated area.

**MFS-K05/90:** The 90° outlet makes the sensor ideal for installation in restricted spaces where axial mounting is not possible.

### Measurement geometry

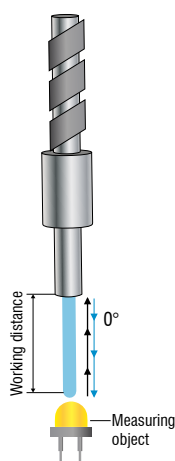

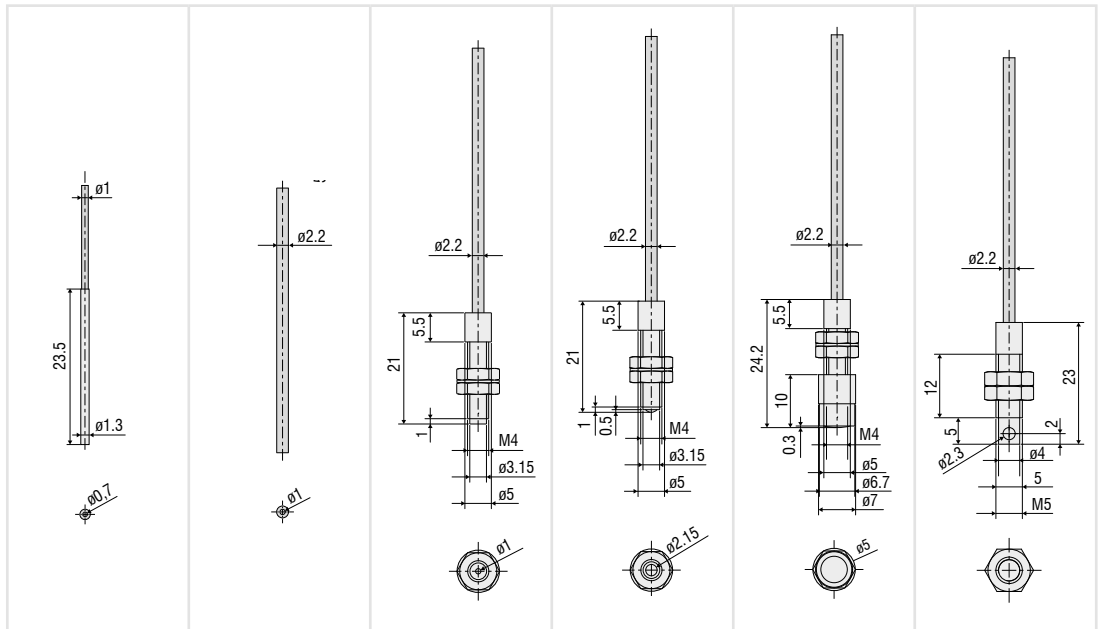

Model	MFS-I01	MFS-22	MFS-K04	MFS-K04-3	MFS-K04-6	MFS-K05/90
Article number	10825516	10825504	10825506	10825508	10825510	10825512
Sensor type	Receiver sensor					
Working distance <sup>1)</sup>	Start	3 mm	3 mm	3 mm	3 mm	3 mm
	Optimal	5 mm	5 mm	5 mm	5 mm	5 mm
	End	11 mm	11 mm	11 mm	15 mm	15 mm
Measurement spot diameter <sup>1)</sup>	Start	4 mm	4 mm	6 mm	2.5 mm	4.5 mm
	Optimal	6 mm	8 mm	8 mm	3 mm	5 mm
	End	13 mm	16 mm	16 mm	6 mm	7 mm
Measurement geometry	0°					90°
Min. target size	Ø 4 mm	Ø 6 mm	Ø 4 mm	Ø 2.5 mm	Ø 4.5 mm	Ø 5 mm
Sensitivity	Distance <sup>2)</sup>	xy < 0.003 /mm	xy < 0.003 /mm	xy < 0.003 /mm	xy < 0.002 /mm	xy < 0.003 /mm
	Tilt angle <sup>2)</sup>	xy < 0.01 / °				xy < 0.02 / °
Connector	integrated plastic fiber cable (axial) with PVC (P) sheath, standard length 0.5 m; other lengths 0.3 m ... 2.0 m optionally available, min. bending radius 50 mm					
Mounting	MFS plug					
Temperature range	Sensor head	-10 ... +80 °C				
	Cables	-20 ... +80 °C				
Air humidity	20 ... 80 % r.H. (non-condensing)					
Protection class (DIN EN 60529)	IP44	IP64	IP44			
Material	Brass, plastic fiber POF-1.0 with PVC sheath (P)	PVC, plastic fiber POF-2.2 with PVC sheath (P)	Aluminum, plastic fiber POF-2.2 with PVC sheath (P)			
Weight	1.3 g	3.4 g	5.4 g	5.6 g	7.2 g	6.7 g
Compatibility	MFA controller (7, 14, 21, 28)					
Special features	All variants are available in other lengths > 300 mm as well. Lengths of up to 5 m are possible with glass optical fibers. These can also be manufactured for vacuum or high-temperature conditions.					
No. of measurement channels	1					

Details apply in conjunction with a colorCONTROL MFA-7 series controller

<sup>1)</sup> Measured with a white reference light source 6500 K, 32 lm, 95 Ra

<sup>2)</sup> Measured with red 637 nm 5 mm LED (1 mA, 11 V DC)

## Sensor system for LED tests colorCONTROL MFA



Multipoint color recognition system



Series with 7 detection points:  
MFA-7, MFA-14, MFA-21, MFA-28



Color inspection in the XYZ, xyY, Luv, uvL  
and RGB color spaces



Color distinction, intensity test &  
functional test



Output of the dominant wavelength ( $\lambda_{dom}$ )  
and color temperature (CCT)



### Features:

- Universal coupling of MFS receiver sensors
- Available with either 7, 14, 21 or 28 measurement channels
- Individual adaption of the sensor configuration
- Each measuring position is freely configurable in terms of color, intensity and function
- Integration into testing process via RS232, RS422 or USB interface
- Output of XYZ, xyY, Luv, uvL, RGB, CCT,  $\lambda_{dom}$  values
- Exchangeable MFS receiver sensors
- Sensor cables with max. 2m-plastic fiber or with max. 5m-glass fibers
- Software for comprehensive evaluation and display

### Applications:

- Testing self-luminous objects
- LED tests (binning)
- Indicator tests
- Display tests
- 7-segment display tests
- Front panel tests

### Function:

The information about color, intensity and light are directly transmitted from the measuring object to the MFA sensor via single fiber bundles. One MFA-28 simultaneously monitors up to 28 specimens.

The inspection of inaccessible specimens and/or specimens that are situated far apart from one another can easily be achieved using the MFA series, as optical fibers transmit the information to the evaluation unit.

### Advantages

- High repeatability
- High measuring rate and dynamics
- Customer-specific MFS sensors (length and design)
- Digital interfaces: USB, RS422 or RS232



Model	MFA-7	MFA-14	MFA-21	MFA-28	
Article number	11094994	11094995	11094996	11094997	
No. of measurement channels	7	14	21	28	
Repeatability <sup>1)</sup>	xy < ±0.000025				
Spectral range	400 ... 700 nm				
Sensitivity range	1 ... 50.000 lx				
Measurement values	XYZ, xyY, Luv, uvL, RGB, CCT, λdom				
Measuring rate <sup>2)</sup>	< 100 Hz	< 80 Hz	< 60 Hz	< 50 Hz	
Temperature stability	Zero point	< 0.09 % FSO / K			
	Sensitivity	< 0.09 % FSO / K			
Supply voltage	+ 24 V DC ±10%				
Maximum power consumption	500 mA				
Digital interface	USB, RS422 or RS232				
Connector	Optical	7 connections or ports for MFS sensors	14 connections or ports for MFS sensors	21 connections or ports for MFS sensors	28 connections or ports for MFS sensors
	Electrical	8-pole M12 socket for RS422 / RS232 / USB 4-pin plug for power supply			
Mounting	Screw connection with four through-holes				
Temperature range	Storage	-10 ... +55 °C			
	Operation	+0 ... +50 °C			
Air humidity	20 ... 80 % r.H. (non-condensing)				
Shock (DIN EN 60068-2-27)	15 g / 6 ms + two directions, 1000 shocks in each of 3 axes				
Vibration (DIN EN 60068-2-6)	2 g / 10 ... 500 Hz + 10 cycles in each of 3 axes				
Protection class (DIN EN 60529)	Front side	IP20			
Material	Aluminum housing, coated in black				
Weight	247 g	262 g	278 g	293 g	
Compatibility	with all MFS sensors				
Control and indicator elements	Status LED (green: smooth operation; orange: error; blue: overmodulation)				

FSO = Full Scale Output

<sup>1)</sup> Maximum color deviation in x and y of 1000 consecutive measurements on red, green, blue and white light of an RGB LED with 12W/m and 300 lm/m. Measured with MFS-K04 sensor at 10 Hz data rate and brightness adjustment to RGB color mixture white with maximum illuminance.

<sup>2)</sup> Valid for a baud rate of 230400 and the transmission of the color values plus time stamp. The measuring rate decreases when transmitting λdom and CCT.



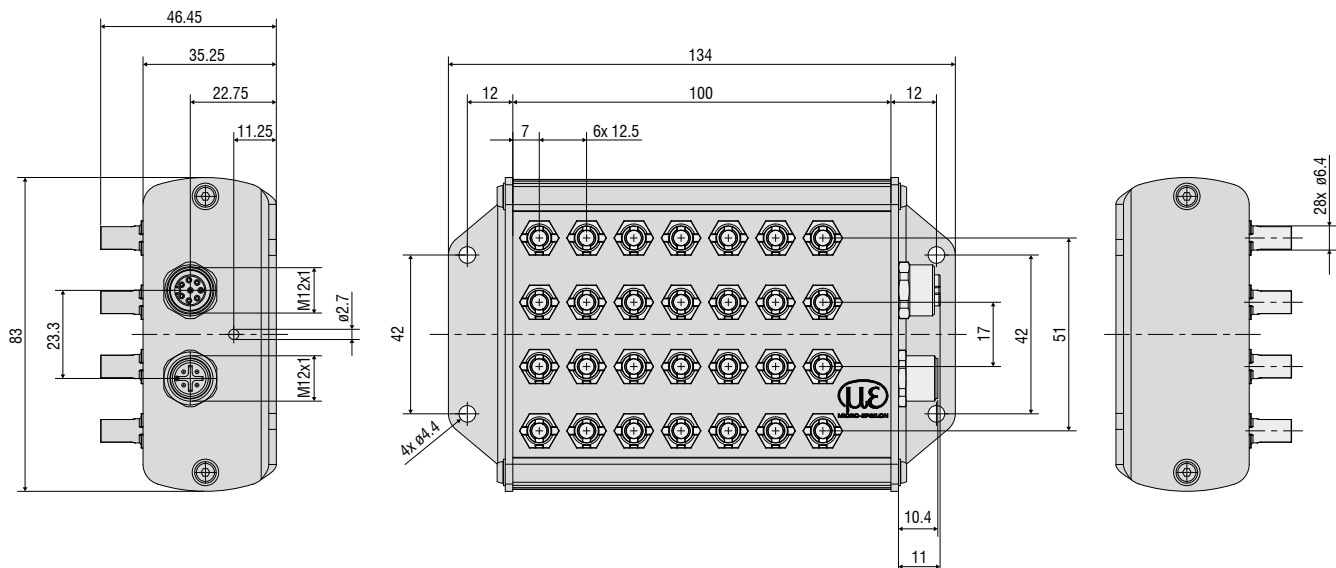

## Dimensions:

Dimensions in mm, not to scale



CFO

## Receiver sensor for self-luminous objects color**SENSOR** CFS5

-  Ideal for testing LEDs / lighting and self-illuminators
-  Detection of minor color and intensity variations
-  For large measurement spot diameters up to 28 mm
-  Max. measurement distance 30 mm
-  Customizable sensors for each application



The CFS5 receiver sensors combined with the powerful CFO controllers enable extremely precise testing of self-luminous devices such as LEDs, lamps, bulbs, spotlights, backlights and displays. The CFS5 receiver sensor with integrated optical fiber receives the light emitted by the luminaire under test at 0° (parallel) to the direction of emission, and transmits it to the controller.

The controller evaluates the transported light and autonomously compares it with the previously taught target color. The sensors detect even the smallest of luminaires such as SMD-LEDs from a size of 4 mm. Due to the extremely small working distance of > 3 mm, installation in very tight installation spaces is easily possible. The large sensor portfolio covers a wide range of working distances and spot sizes. In addition, other versions with different lengths, temperature ranges and vacuum-suitability are available. Special models with multi-channel variants or versions with a 90° outlet are available on request.

### Measurement geometry

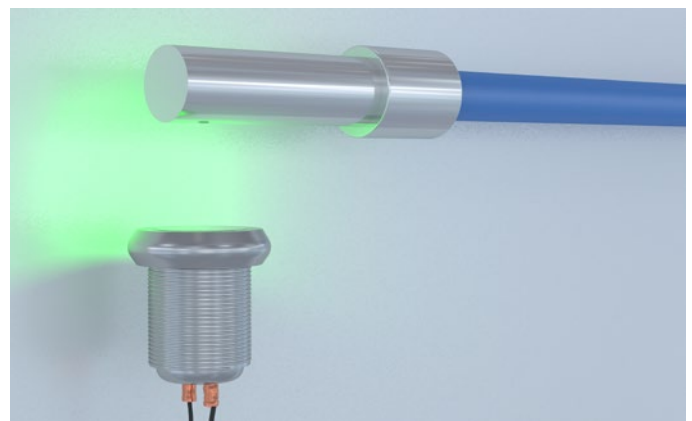
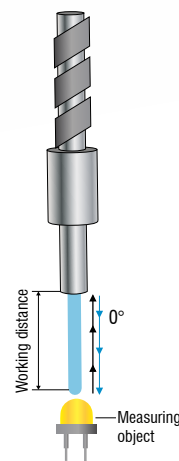

### Quality control of LED stainless steel lights

Their optional design with 90° deflection makes the CFS sensors from Micro-Epsilon the optimum solution for confined installation spaces where the installation depth and mounting space are extremely limited.

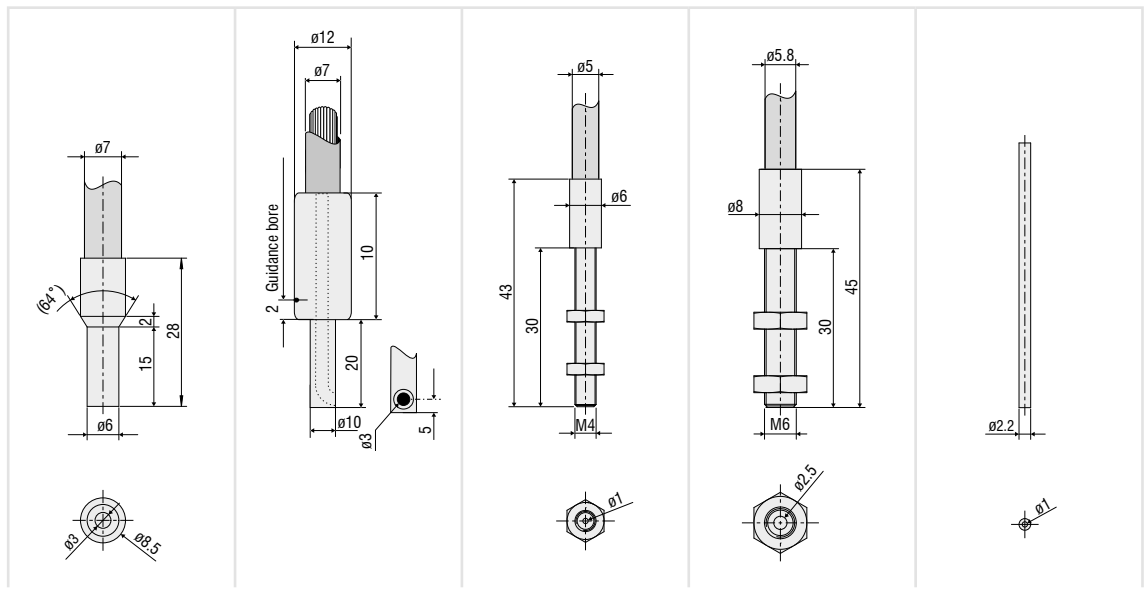

Model		CFS5-A30-600	CFS5-F30/90	CFS5-C10-M	CFS5-C20-600	CFS5-22-1000
Article number		10812145	10815567	10812287	10814208	10815532
Sensor type		Receiver sensor				
Working distance <sup>1)</sup>	Start	5 mm	5 mm	5 mm	5 mm	3 mm
	Optimal	5 mm	5 mm	5 mm	5 mm	5 mm
	End	20 mm	20 mm	15 mm	15 mm	15 mm
Measurement spot diameter <sup>1)</sup>	Start	6 mm	6 mm	4 mm	5 mm	4 mm
	Optimal	6 mm	6 mm	4 mm	5 mm	5 mm
	End	14 mm	14 mm	9,5 mm	10 mm	11 mm
Measurement geometry		0°				
Min. target size (flat)		Ø 6 mm	Ø 6 mm	Ø 4 mm	Ø 5 mm	Ø 4 mm
Sensitivity	Distance <sup>2)</sup>	xy < 0.002 /mm	xy < 0.002 /mm	xy < 0.002 /mm	xy < 0.002 /mm	xy < 0.001 /mm
	Tilt angle <sup>2)</sup>	xy < 0.0002 / °	xy < 0.002 / °	xy < 0.0005 / °	xy < 0.0002 /mm	xy < 0.001 / °
Connector		integrated glass fiber cable (axial) with metal-silicone (T) sheath, standard length 1.2 m; other lengths 0.3 m ... 2.4 m optionally available	integrated glass fiber cable (axial) with metal-silicone (T) sheath, standard length 1.2 m; other lengths 0.3 m ... 2.4 m optionally available	integrated glass fiber cable (axial) with metal (M) sheath, standard length 1.2 m; other lengths 0.3 m ... 2.4 m optionally available	integrated glass fiber cable (axial) with metal-silicone (T) sheath, standard length 1.2 m; other lengths 0.3 m ... 2.4 m optionally available	integrated plastic fiber cable (axial) with PVC (P) sheath, standard length 0.5 m; other lengths 0.3 m ... 2.0 m optionally available, min. bending radius 50 mm
Mounting		FA (M18x1)				
Temperature range	Storage / Operation	Sensor head: -10 ... +80 °C Cable: -60 ... +180 °C	Sensor head: -10 ... +80 °C Cable: -60 ... +180 °C	Sensor head: -10 ... +80 °C Cable: -40 ... +300 °C	Sensor head: -10 ... +80 °C Cable: -60 ... +180 °C	Sensor head: -10 ... +80 °C Cable: -20 ... +80 °C
	Air humidity	20 ... 80 % RH (non-condensing)	20 ... 80 % RH (non-condensing)	20 ... 60 % RH (non-condensing)	20 ... 80 % RH (non-condensing)	20 ... 80 % RH (non-condensing)
Protection class (DIN EN 60529)		IP64	IP64	IP40	IP64	IP64
Material		Stainless steel, fiberglass bundle with metal-silicone sheath (T)	Stainless steel, fiberglass bundle with metal-silicone sheath (T)	Stainless steel, fiberglass bundle with metal sheath (M)	Stainless steel, fiberglass bundle with metal-silicone sheath (T)	PVC, plastic fiber POF-2.2 with PVC sheath (P)
Weight		64 g	118 g	66 g	100 g	16 g
Compatibility		CFO controller				
Special features		All variants are also available with different cable sheath, length 0.3 ... 2.4 m, vibration protection, IP protection, suitable for drag chains and for temperature ranges up to 2,000 °C. In combination with a pressure-tight feed-through, a stainless steel sheath and T250° bonding, vacuum applications down to 10 <sup>-5</sup> mbar are also possible.				

Details apply in conjunction with a colorSENSOR CFO200 controller  
<sup>1)</sup> Measured with a white reference light source 6500 K, 32 lm, 95 Ra  
<sup>2)</sup> Measured with red 637 nm, 5 mm, LED (1 mA, 11 V DC)

CFO

# Universal True Color sensor controller color**SENSOR** CFO100



Repeatability in color  $\Delta E \leq 0.5$



Measuring rate up to 10 kHz



Interfaces: Ethernet / RS232



Color memory for 256 colors in 6 color groups



Configurable via web interface  
or function keys



High light output >130 lm



Multi-teach feature



The color**SENSOR** CFO100 is a powerful controller for precise color recognition in industrial measurement tasks. The controller is distinguished by high color accuracy, state-of-the-art interfaces and intuitive operation.

The light emitted by the measuring object is directed via an optical fiber to a perceptive true-color detector element and divided into X = long-wave, Y = medium-wave, and Z = short-wave light components and transformed into L\*a\*b\* color values.

The intuitive web interface allows easy teach-in of 6 color groups with up to 256 colors in total. Multi-teach can alternatively be done via the keys. One function alone adapts the illumination, averaging and signal amplification to the current measurement situation. Furthermore, tolerance models and tolerance values can be adjusted individually. If the sensor recognizes one of the taught colors, the switching state changes via three digital outputs. Using the binary output switching ensures reliable test performance in the face of a discontinuity while providing output of up to 6 color groups.



Settings can also be made in the web interface or via the keys on the controller.

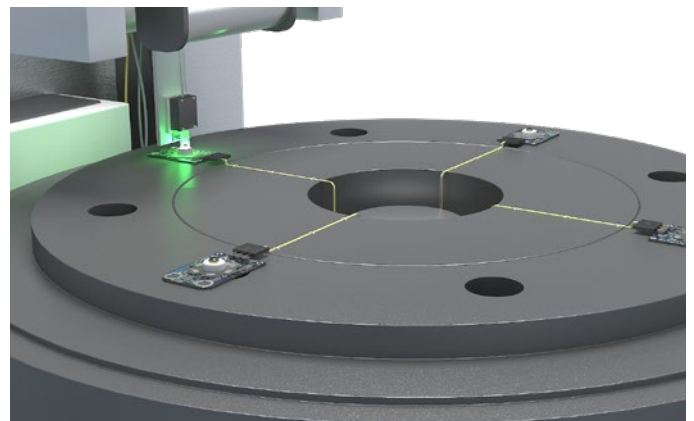

Automated status monitoring of status LEDs on electrical circuit boards



Model	CFO100	CFO100(100)
Article number	10234670	10234670.100
No. of measurement channels	1	
Repeatability <sup>1)</sup>	$\Delta E \leq 0.5$	
Color difference	$\Delta E \leq 1.0$	
Spectral range	400 ... 680 nm	
Color spaces	XYZ, xyY, L*a*b*, L*u*v*, u'v'L*	
Illuminants	D65	
Standard observer	2°	
Tolerance model	Classify; sphere ( $\Delta E$ ); cylinder ( $\Delta L$ , $\Delta ab$ ); box ( $\Delta L$ , $\Delta a$ , $\Delta b$ )	
Color memory	max. 256 colors in non-volatile EEPROM with parameter sets	
Measuring rate	max. 10 kHz, standard 1 kHz (depending on number of colors learned and setting for averaging)	
Temperature stability	< 0.1 % FSO / K	
Light source	white light LED (425 ... 750 nm); AC operation (luminous flux at 1 kHz 130 lm) (adjustable or OFF for primary light source, switchable via software)	
Permissible ambient light	max. 40,000 lx (depending on the CFS sensor)	
Synchronization	Synchronization is possible	
Supply voltage	18 ... 28 VDC	
Maximum power consumption	500 mA	
Signal input	1 (IN0), configurable via keys or web interface (trigger, teach, delete, lock, calibration)	
Digital interface	RS232 (standard 9600 Baud) <sup>2)</sup> , Ethernet	Ethernet, Modbus (TCP/RTU), PROFINET <sup>3)</sup> , EtherNet/IP <sup>3)</sup> , EtherCAT <sup>3)</sup>
Switching output	OUT0-OUT2 Push-Pull / NPN / PNP (color recognition, binary coding 6 color groups)	
Connector	Optical	screwable optical fiber via FA socket M18x1, length 0.3 m ... 2.4 m, min. bending radius 18 mm
	Electrical	8-pin flange connector M12A (Power/PLC); 4-pin flange socket M12D (PC/Ethernet DHCP-capable); (connection cable see accessories)
Mounting	DIN rail mounting/screw connection via adapter (see accessories)	
Temperature range	Storage	-10 ... +85 °C
	Operation	-10 ... +55 °C
Air humidity	20 ... 80 % r.H. (non-condensing)	
Shock (DIN EN 60068-2-27)	15 g / 6 ms in 3 axes in two directions, 1000 shocks each	
Vibration (DIN EN 60068-2-6)	2 g / 10 ... 500 Hz in 3 axes, 10 cycles each	
Protection class (DIN EN 60529)	IP65 (when connected)	
Material	Aluminum, black anodized	
Weight	approx. 200 g	
Compatibility	with all CFS sensors <sup>4)</sup>	
Control and indicator elements	Operation via keys and web interface, visualization with 13 white LEDs	
Special features	Multi-color teach function, automatic adjustment of illumination brightness, measurement signal amplification and averaging depending on the measurement frequency, adjustable hold time of > 30 $\mu$ s	

FSO = Full Scale Output

<sup>1)</sup> Maximum color distance  $\Delta E$  of 1000 successive measurements of the color value of a red and a dark gray reference tile (R = 5%), measured with the CFS4-A20 sensor at 1000 Hz and brightness adjustment with a white standard (R=95%)

<sup>2)</sup> Adjustable up to max. 115200 Baud

<sup>3)</sup> Optional connection via interface module

<sup>4)</sup> Also compatible with previous series (FAR, FAD, FAL, FAZ and FAS)

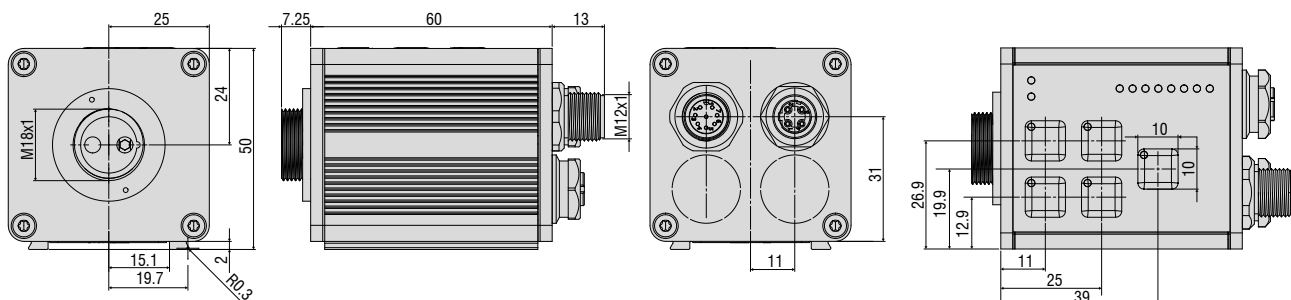

Dimensions in mm, not to scale



Repeatability in color  $\Delta E \leq 0.3$



Measuring rate up to 30 kHz



Interfaces: Ethernet / Modbus / RS232 / USB



Color memory for 320 colors in 254 color groups



Configurable via web interface or function keys



High light output >220 lm



Multi-teach feature



Also suitable for color control of self-luminous objects



The color**SENSOR** CFO200 is a high-performance controller for precise color recognition in industrial measurement tasks. The controller is distinguished by high color accuracy, state-of-the-art interfaces and intuitive operation.

The light emitted by the measuring object is directed via an optical fiber to a perceptive true-color detector element and divided into X = long-wave, Y = medium-wave, and Z = short-wave light components and transformed into  $L^*a^*b^*$  color values.

The intuitive web interface allows easy teach-in of 254 color groups with 320 colors in total. Multi-teach can alternatively be done via the keys. One function alone adapts the illumination, averaging and signal amplification to the current measurement situation. Furthermore, tolerance models and tolerance values can be adjusted individually.

If the sensor recognizes one of the taught colors, the switching state changes via 8 digital outputs. Using the binary output switching ensures reliable test performance in the face of a discontinuity while providing output of up to 254 color groups.

The CFO controller is also suitable for detecting the color of self-luminous objects. For this purpose, the internal illumination can optionally be deactivated via the software.

EtherCAT

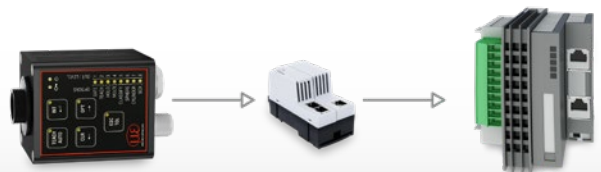

#### Ideal for integration in modern environments

The CFO200 can be connected via Ethernet, Modbus, RS232 and USB. Via an additional interface module, PROFINET, Ethernet/IP and EtherCAT are available.



#### Brightness testing of LED line lights

After the production of LED strips and line lights, a 100 percent inspection of all installed LEDs is carried out in the quality assurance department. The CFO200 controller is used, which is ideal for inline applications due to its high measuring rate of up to 30 kHz.

Model	CFO200	CFO200(100)
Article number	10234671	10234671.100
No. of measurement channels	1	
Repeatability <sup>1)</sup>	$\Delta E \leq 0.3$	
Color difference	$\Delta E \leq 0.6$	
Spectral range	400 ... 680 nm	
Color spaces	XYZ, xyY, L*a*b*, L*u*v*, u'v'L*	
Illuminants	D65	
Standard observer	2°	
Tolerance model	Classify; sphere ( $\Delta E$ ); cylinder ( $\Delta L$ , $\Delta ab$ ); box ( $\Delta L$ , $\Delta a$ , $\Delta b$ )	
Color memory	max. 320 colors in non-volatile EEPROM with parameter sets	
Measuring rate	standard 1 kHz; max. 30 kHz (depending on number of colors learned and setting for averaging)	
Temperature stability	< 0.1 % FSO / K	
Light source	white light LED (425 ... 750 nm); AC operation (luminous flux at 1 kHz 220 lm) (adjustable or OFF for primary light source, switchable via software)	
Permissible ambient light	max. 40,000 lx (depending the CFS sensor)	
Synchronization	Synchronization is possible	
Supply voltage	18 ... 28 VDC	
Maximum power consumption	500 mA	
Signal input	4 (IN0-IN3): IN0 via keys; IN0-IN3 configurable via web interface (trigger, teach, delete, lock, calibration)	
Digital interface	RS232 (standard 9600 Baud) <sup>2)</sup> , Ethernet, USB	Ethernet, Modbus (TCP/RTU), USB, PROFINET <sup>3)</sup> , EtherNet/IP <sup>3)</sup> , EtherCAT <sup>3)</sup>
Switching output	OUT0-OUT7 Push-Pull / NPN / PNP (color recognition, binary coding 254 color groups)	
Connector	Optical	screwable optical fiber via FA socket M18x1, length 0.3 m ... 2.4 m, min. bending radius 18 mm
	Electrical	8-pin flange socket M12A (Power/PLC); 8-pin flange socket M12A (signal); 4-pin flange socket M12D (Ethernet DHC capable); 5-pin flange socket M12A (USB) (connection cable see accessories)
Mounting	DIN rail mounting/screw connection via adapter (see accessories)	
Temperature range	Storage	-10 ... +85 °C
	Operation	-10 ... +55 °C
Air humidity	20 ... 80 % r. H. (non-condensing)	
Shock (DIN EN 60068-2-27)	15 g / 6 ms in 3 axes, two directions and 1000 shock each	
Vibration (DIN EN 60068-2-6)	2 g / 10 ... 500 Hz in 3 axes, 10 cycles each	
Protection class (DIN EN 60529)	IP65 (when connected)	
Material	Aluminum, black anodized	
Weight	approx. 200 g	
Compatibility	with all CFS sensors <sup>4)</sup>	
Control and indicator elements	Operation via keys and web interface, visualization with 13 white LEDs	
Special features	Multi-color teach function, automatic adjustment of illumination brightness, measurement signal amplification and averaging depending on the measurement frequency, adjustable hold time of > 30 $\mu$ s	

FSO = Full Scale Output

<sup>1)</sup> Maximum color distance  $\Delta E$  of 1000 successive measurements of the color value of a red and a dark gray reference tile (R = 5%), measured with the CFS4-A20 sensor at 1000 Hz and brightness adjustment with a white standard (R=95%)

<sup>2)</sup> Adjustable up to max. 115200 Baud

<sup>3)</sup> Optional connection via interface module

<sup>4)</sup> Also compatible with previous series (FAR, FAD, FAL, FAZ and FAS)

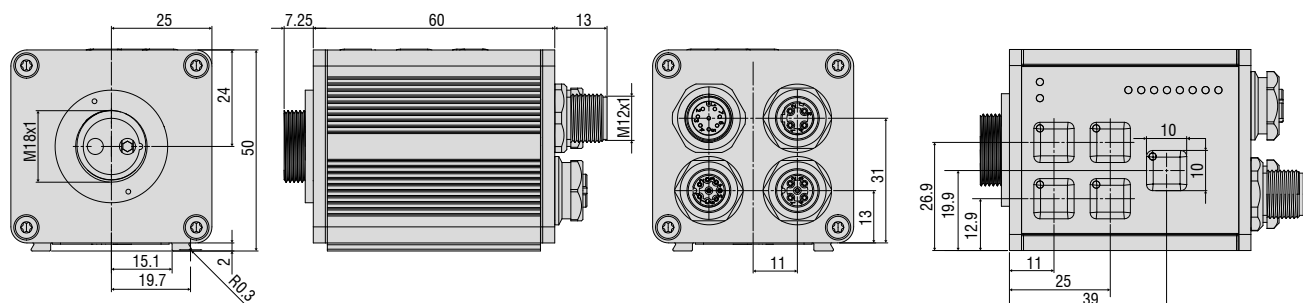

Dimensions in mm, not to scale

ACS

# Transmission sensor colorCONTROL ACS3



Measuring self-luminous objects using the colorCONTROL ACS7000



Measurement distance: max. 200 mm

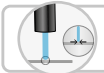

Measurement spot:  $\varnothing 5 / \varnothing 9$  mm



The ACS3-TR transmission sensor is applied for measurements of self-luminous objects and objects illuminated from behind such as film, glass and Plexiglas®. Only the receiver unit of the ACS3 transmission sensor is required to measure the color of self-luminaires.

In combination with the ACS7000 spectral color measuring system, the measured illumination can not only be checked in terms of function, color and brightness, but the corresponding spectral light distribution from 390 to 780 nm is also obtained. The color measurement is performed based on a spectral analysis, in which the incident light is refracted into individual spectral ranges to check their intensity distribution. The peak wavelength and color distribution are reliably displayed and evaluated within the illumination.

When measuring backlit control panels, the spectral method can be used to precisely measure not only the light color of the display but also the influence (transmission) of the display glass and the imprint. With this measurement method, LEDs can be precisely measured with a repeatability of  $\Delta E \leq 0.08$ .

The ACS7000 transmits the measurement data transmitted at up to 2,000 Hz to a control system for logging or evaluation.

## Measurement geometry

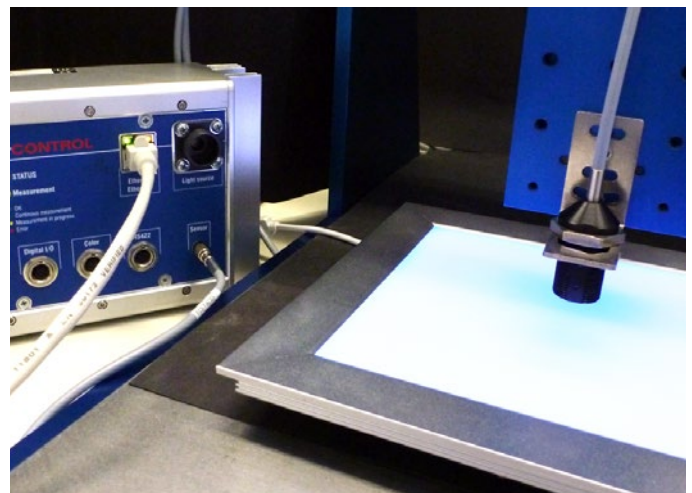
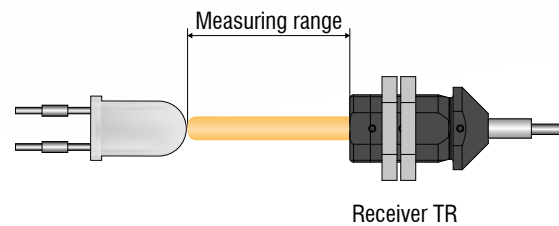

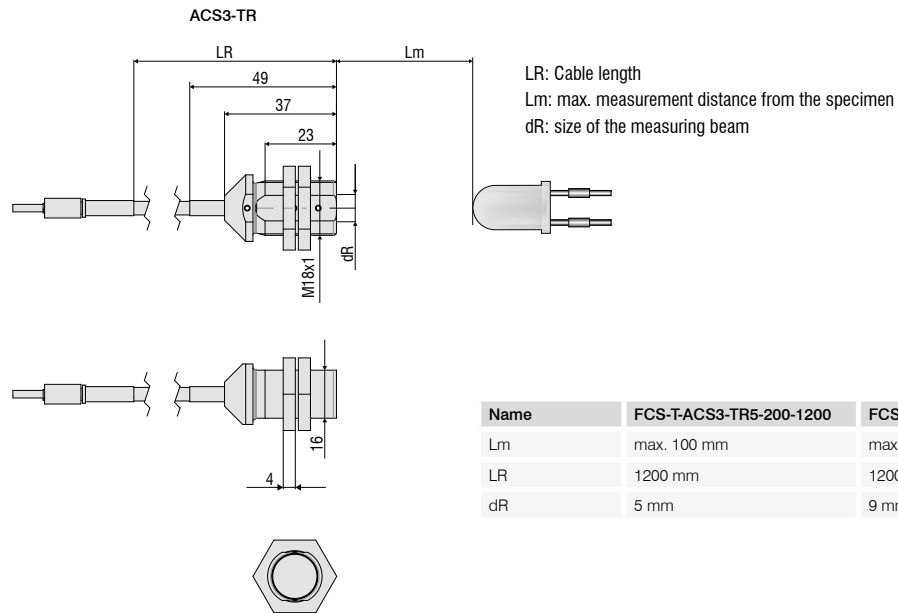

Fiber-optic sensor FCS-T-	ACS3-TR5-200-1200	ACS3-TR9-200-1200
Article number	10824411	10824412
Measurement geometry (illumination : receiver)	Receiver	Receiver
Measurement spot diameter	5 mm with <100 mm <sup>1)</sup>	9 mm with <200 mm <sup>1)</sup>
Optimal measurement distance	10 ... 100 mm	10 ... 200 mm
Permissible measurement distance	10 ... 200 mm	10 ... 300 mm
Distance tolerance <sup>2)</sup>	<0.01 ΔE/mm <sup>3)</sup>	<0.01 ΔE/mm <sup>3)</sup>
Tilt angle tolerance <sup>2)</sup>	<0.05 ΔE/°	<0.05 ΔE/°
Ambient light tolerance at max. LED power	<0.05 ΔE/1000 lux	<0.05 ΔE/1000 lux
Dimensions	Ø 22 x 40 mm	Ø 22 x 40 mm
Weight (sensor incl. optical fiber)	70 g	70 g
Length of the optical fiber/sensor cable (optical-fiber cable)	1.2 m (max 30 m)	1.2 m (max 30 m)
Bending radius sensor cable	70 mm	70 mm
Protection class	IP64	IP64
Operating temperature	-20 °C ... +50 °C	-20 °C ... +50 °C
Storage temperature	-20 °C ... +50 °C	-20 °C ... +50 °C
Shock resistance	DIN EN 60068-2-29; 15 g, 6 ms	
Vibration resistance	DIN EN 60068-2-6; 2 g / 10 Hz ... 500 Hz	

<sup>1)</sup> Measurement spot diverges with increasing distance between receiver and target

<sup>2)</sup> Tilt angle tolerance and distance tolerance were determined in transmission with different color glass filters (thickness 2.5 mm, refraction index 1.5). When measuring the illumination (only receiver), these were determined with uniformly illuminated (Lambertian) diffuser by tilting the transmitter towards the receiver.

<sup>3)</sup> When using it as receiver sensor for illumination measurement



Inline color measurement



Non-contact measurement



Measurement accuracy is  $\Delta E \leq 0.08$   
(sample-related)



Measurement frequency  
from 25 Hz - 2000 Hz



Ethernet/EtherCAT, RS422, Digital I/O



Web browser operation



## Features:

- Light source: adjustable standard illuminant and observer
- Color spaces (adjustable) : XYZ; L\*a\*b\*; L\* u\* v\*; L\*c\*h
- Color recognition from a taught reference list
- White/black reference comparison  
(via browser and keys on the device)
- Inline quality assurance and continuous documentation
- Spectral evaluation of the illumination spectrum
- Easy parameter setup via web application

The colorCONTROL ACS7000 inline color measuring system recognizes colors not just by comparing them to reference values, but also by using their coordinates in the respective color space to ensure unique identification. Due to its very high measurement speeds, the colorCONTROL ACS7000 is suitable for applications where colors and self-luminous objects have to be inspected on-the-fly and to very high accuracies. Due to its extremely high measurement accuracy, the system is also applied in laboratories.

## Measuring principle

The spectral method is the most accurate method of color measurement. The received light is spectrally decomposed into 1.6 nm increments and then compared with a white reference. Then the coordinates in the CIE-XYZ color system are determined for all wavelengths of visible light (390 to 780 nm) and output in the desired color space. The controller takes into account different observation conditions such as the type of light (illuminant) and standard observer.

## Function

Three operating modes are possible with the colorCONTROL ACS7000. In the first mode, the color distance  $\Delta E$  is measured for reference. The system operates with up to 15 taught values. The second mode determines and outputs the reflectivity spectrum of the sample. The third mode determines color coordinates and displays these in the desired color space. For quality inspection purposes, a trend analysis can be performed over any time period via L\*a\*b\*; XYZ or L\*c\*h color values.

All modes support measurement speeds up to 2 kHz. Operation and display are performed via a web interface. Light/dark correction can also be carried out using buttons on the controller or through the user interface. Ethernet/EtherCAT, RS422 and digital I/Os are available for data output.

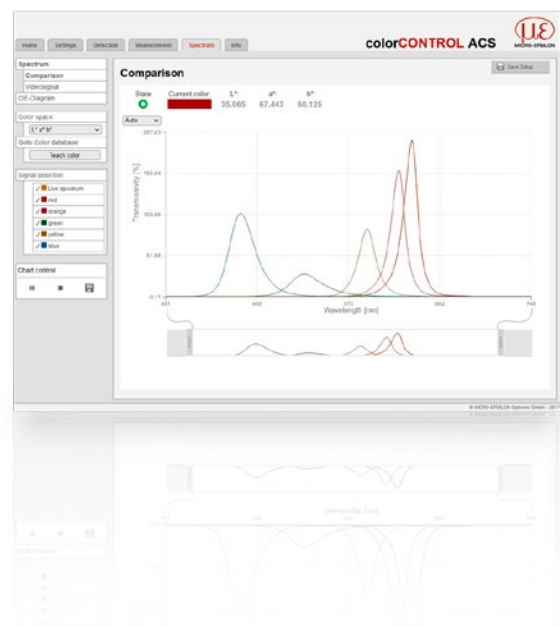

Model	Controller, colorCONTROL ACS7000
Article number	11104174
Spectral measuring range	390 - 780 nm
Measuring range reflectivity	0 - 200 %R
Output values	L*a*b*, L*u*v*, L*c*h°, XYZ, ΔE, spectrum
Illuminants	A, C, D65, D50, D75, E, F4, F7, F11, Off
Standard observer	2°, 10°
Distance models for color recognition	Sphere (ΔE), cylinder (ΔL*, Δa*b*), box (ΔL*, Δa*, Δb*), with individual tolerance parameters for every color taught
Color resolution	0.01 ΔE
Spectral resolution	5 nm
Measurement frequency	25 - 2000 Hz (internal spectrum, signal averaging and data reduction are possible)
Temperature stability	<0.1 ΔE/°C
Light source	LED, 390 - 780 nm
Repeatability of the measurements of a device <sup>1)</sup>	<0.03 (mean); <0.08 (max) ΔE
Housing dimensions	210 x 120 x 90 mm (WxHxD)
Weight	1.8 kg
Protection class	IP40
Operating temperature	0 °C to 45°C
Storage temperature	-20 °C to 70°C
Inputs / outputs	4 color detection switching outputs (4 individual colors or 15 colors binary or {ΔE, ΔL* Δa*, Δb*} for one color) 1 Switching output, synchronization 1 Switching input, synchronization 1 Switching output, measurement error
Interfaces	Ethernet/EtherCAT (DHCP-enabled) RS422 (USB via RS422 adapter is possible)
Connection for fiber optics	Illumination: 7mm ferrule with M18 cap (union) nut (analogous to MICRO-EPSILON Eltrotec Fasop system) Measurement: DIN fiber connector
Connection cables	To power supply: art. no. 11234222 / to PLC: art. no. 11234223 / to synchronization: art. no. 11234091 / to PC: art. no. 11294232 (Ethernet/EtherCAT); 11234224 or 11234230 (RS422)
Additional data processing	Internal calculation of spectral characteristics, color valence calculations, color space transformations, ΔE calculations, and tolerance settings of the upper and lower thresholds for the color values
Connection to software	Control and configuration via integrated Web server or via terminal with commands Visualization of spectral characteristics and temporal sequence of the color values and color differences
Power supply	24 VDC ±15 % 1000 mA
Service life of the light source	>20000 h when operated at 25 °C



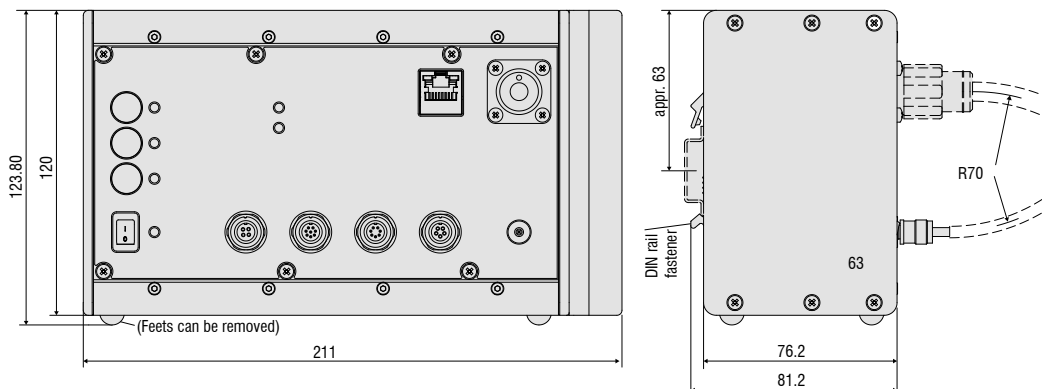











<sup>1)</sup> Medium or maximum color distance ΔE of 1000 successive measurements of the color value (mean) of a light gray reference tile (R = 61%), measured with sensor FCS-T-ACS1-30/0-50-1200 at 200 Hz and maximum illumination brightness



# Connection cables & Accessories

## colorSENSOR /colorCONTROL

### MFA colorCONTROL MFA

Connection cables		Installation	Sensor
Power supply Power supply unit PS2031 Art. no. 2420096 	Art. no. 11235030 (2 m) 11235031 (5 m) 11235032 (10 m) 		MFS-22 
Process interface (USB) 	Art. no. 11235025 (2 m) 		MFS-I01 
RS232 	Art. no. 11235027 (2 m) 11235028 (5 m) 11235029 (10 m) 		MFS-K04 
RS422 	Art. no. 11234722 (2 m) 11234723 (5 m) 11234725 (10 m) 		MFS-K04-3 
			MFS-K04-6 
		MFS-K05/90 	





Connection cables		Installation	Sensor	Accessories
Supply/RS232 Power supply unit PS2031 Art. no. 2420096 Connection PLC (I/O)	Art. no. 11234717 (2 m) 11234718 (5 m)		CFS5-22-1000	White standard Art. no. 11234694 11234695
Digital output/ Ethernet	Art. no. 11234735 (2 m) 11234736 (5 m)		CFS5-F30/90	Vacuum feed-through Art. no. 10811916
Connection PLC (I/O)	Art. no. 11234722 (2 m) 11234723 (5 m)		CFS5-A300	C-mount lens Art. no. 11293186 and others
Process interface (USB)	Art. no. 11234732 (2 m) 11234733 (5 m)		CFS5-C10-M	
			Mounting adapter Art. no. 11234713 11234762 11234763	CFS5-C20-600

# Connection cables & Accessories

## colorSENSOR /colorCONTROL

### ACS colorCONTROL ACS

Connection cables		Installation	Sensor	Accessories
Power supply Power supply unit PS2030 Art. no. 2420065 	Art. no.: 11234222 (2 m) 11234225 (5 m)			White standard Art. no.: 11234694 ø30 mm 11234695 ø30 mm (calibrated) 11234696 5x5 cm 11234697 5x5 cm (calibrated)
Digital I/O, sync. 	Art. no.: 11234091 (2 m) 11234099 (5 m)			
Color out 	Art. no.: 11234223 (2 m) 11234226 (5 m)			90° attachment Art. no.: 10824804
Ethernet/-CAT 	Art. no.: 11294232 (2 m) 11293257 (5 m) 11294277 (3 m) 11293258 (5 m)			Adapter TT-TR Art. no.: 10824424
RS422 	Art. no.: 11234224 (2 m) 11234227 (5 m)			
IF2001 Art. no. 2213025 	Art. no.: 11234230 (2 m) 11234231 (5 m)			
IF2030 Art. no.: 	Art. no.: PNET ENETIP			

# Optional accessories for colorSENSOR CFS sensors

➔ All sensors can be customized. We would be pleased to manufacture your sensor according to your drawing. Contact us at [eltrotec@micro-epsilon.de](mailto:eltrotec@micro-epsilon.de).

## Examples of customer-specific modifications

### Function

- Special types for CFS5 receiver sensor

### Optical fiber sheath

- Silicone-metal sheath
- VA stainless-steel sheath
- Metal sheath
- PVC metal sheath
- PVC special sheath
- BOA special sheath
- MA-radius-limiting special sheath

### Fiber bundle diameter

- 0.6 / 1 / 1.5 / 2.5 / 3 mm

### Optical fiber (length)

- Available from 300 mm
- Standard length 1,200 mm
- 600, 1,800 and 2,400 mm optionally available
- Individual length of 0.3 ... 2.4 m possible

### Aperture angle

- Standard 67°
- Optional 22° / 35°

### Ambient conditions

- Special versions with increased vibration resistance (VS)
- Special variants with special bonding for high temperatures (T250 / T400)
- Pressure-tight special variants with vacuum feed-through (up to  $10^{-5}$  mbar)

### Mountable lenses

- Focusing for small light spots ( $> 0.8$  mm)
- Large object distances (= distance between sensor and measuring object) up to 200 mm
- Distances  $> 300$  mm with C-mount lens

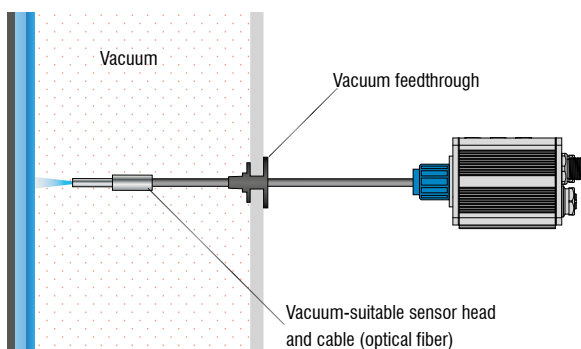
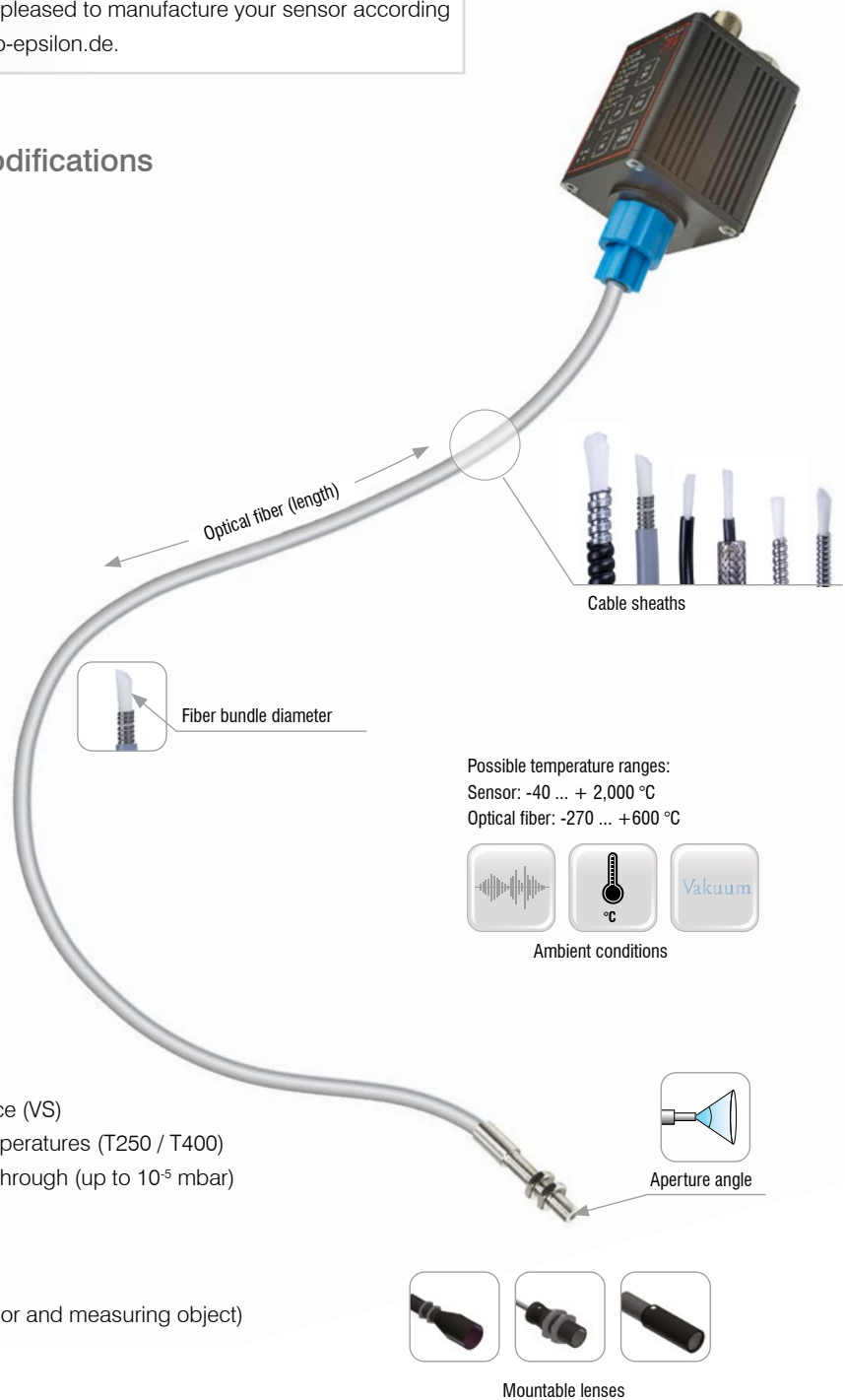

### Vacuum suitability

The color sensors and optical fibers consist of passive components and do not give off heat. In vacuum, sensors (temperature bonding T250), optical fibers (stainless steel sheath), and the vacuum feed-through up to  $10^{-5}$  mbar can be used.



Sensors and systems for displacement, distance and position



Sensors and measurement devices for non-contact temperature measurement



Measuring and inspection systems for metal strips, plastics and rubber



Optical micrometers and fiber optics, measuring and test amplifiers



Color recognition sensors, LED analyzers and inline color spectrometers



3D measurement technology for dimensional testing and surface inspection