



More Precision

confocalDT // Confocal chromatic sensor system







NEW

High performance sensor system with integrated controller
Now also with Ethernet

Micro-Epsilon's latest all-in-one sensor systems, the IFD2410 and IFD2415, are the best in their class worldwide. These handy systems are not only easy to operate and integrate, but also extremely powerful. These compact systems are particularly suitable for series-production machines and systems and have been equipped with the most important fieldbus interfaces (Industrial Ethernet) for this





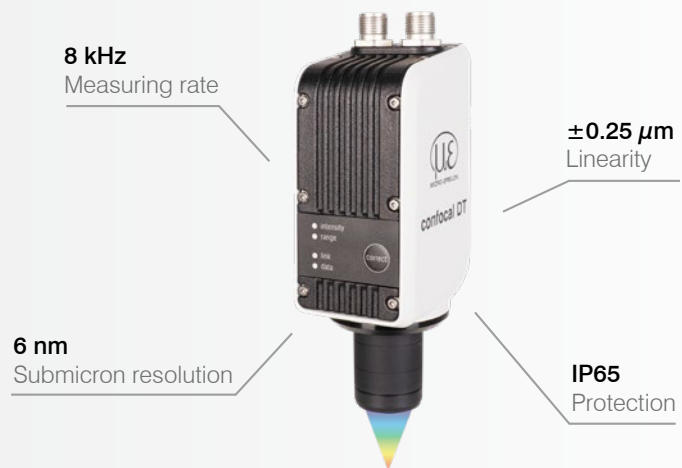

purpose. An Ethernet interface was previously only available for setup and configuration. The IFD2410 and IFD2415 sensor systems are now also available with an integrated Ethernet interface for data output. This allows measurement data to be output with a higher resolution (32 bits) than with the RS422 interface (18 bits).

confocalDT IFD2410

-  All-in-One: sensor and controller in one compact housing (IP65)
-  Adjustable measuring rate up to 8 kHz
-  Simple integration without optical fibers
-  **INTERFACE** EtherCAT / PROFINET / EtherNet/IP / Ethernet / RS422 / Analog
-  Micron-precise measurement of distance and thickness



confocalDT IFD2415



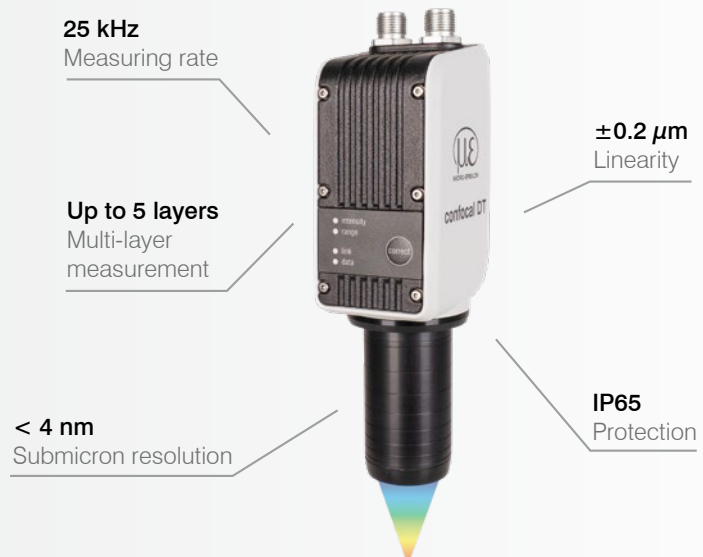



-  All-in-One: sensor and controller in one compact housing (IP65)
-  Adjustable measuring rate up to 25 kHz
-  **INTERFACE** EtherCAT / PROFINET / EtherNet/IP / Ethernet / RS422 / Analog
-  Micron-precise measurement of distance and thickness
-  High precision distance and thickness measurements (5 layers)
-  Short exposure time due to high light intensity



More details from p. 48.

High performance sensor system with integrated controller

confocalDT IFD2415

-  All-in-One: sensor and controller in one compact housing (IP65)
-  Adjustable measuring rate up to 25 kHz
-  **INTER FACE** EtherCAT / PROFINET / EtherNet/IP / Ethernet / RS422 / Analog
-  Micron-precise measurement of distance and thickness
-  High precision distance and thickness measurements (5 layers)
-  Short exposure time due to high light intensity



All-in-One: compact confocal sensor with highest performance

The confocalDT IFD2415 is a powerful confocal sensor with integrated controller. The space-saving IP65 housing enables fast integration into systems and machines as no optical fiber is required. Furthermore, the IFD2415 is ideally suited to high precision distance and thickness measurements in industrial series applications. In addition, the sensor can be used with transparent materials for multi-layer thickness measurements of up to 5 layers.

The active exposure time regulation of the CCD line enables fast and stable measurements of varying surfaces even in dynamic measurement processes up to 25 kHz. The measuring system is also characterized by high luminous intensity which enables fast and reliable measurements even on darker surfaces.

Intelligent technology with high performance and ease of use

In Ethernet mode, the confocalDT IFD2415 can be set via the intuitive web interface. Industrial Ethernet ensures that the settings are automatically transferred to the PLC environment. This eliminates time-consuming setting efforts in the programming environment.

Fast, precise and compact

The unique combination of sensor and controller, together with excellent performance and high measuring rate make the confocalDT IFD2415 the best in its class. This compact sensor can be used in series applications such as, e.g., in inline inspection machines, robots, 3D printers and coordinate measuring machines.

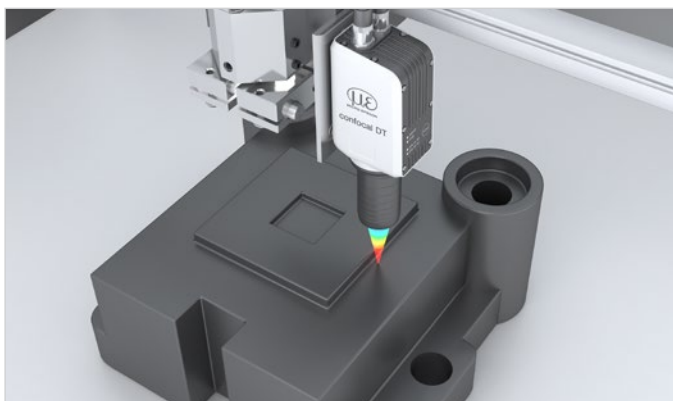

Displacement and distance measurement in 3D printing

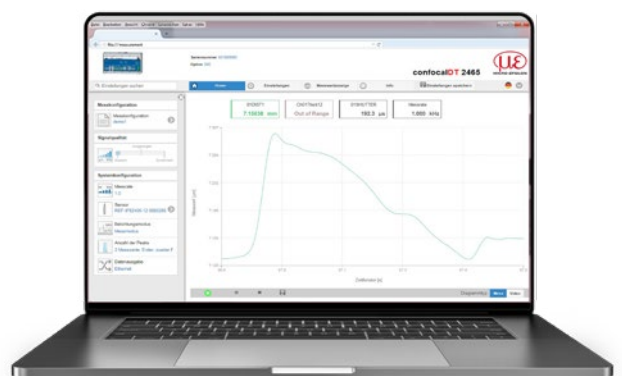

Easy setup and configuration via integrated web interface

Model		IFD2415-1/IE	IFD2415-3/IE	IFD2415-10/IE
Measuring range		1 mm	3 mm	10 mm
Start of measuring range		approx. 10 mm	approx. 20 mm	approx. 50 mm
Resolution	Static ^[1]	< 4 nm	< 8 nm	< 18 nm
	Dynamic ^[2]	< 38 nm	< 80 nm	< 204 nm
Measuring rate		Continuously adjustable from 100 Hz to 25 kHz		
Linearity ^[3]	Displacement and distance	< ±0.2 μm	< ±0.6 μm	< ±2 μm
	Thickness	< ±0.4 μm	< ±1.2 μm	< ±4 μm
Multi-peak measurement		5 layers		
Light source		Internal white LED		
Permissible ambient light		30.000 lx		
Light spot diameter ^[4]		8 μm	9 μm	16 μm
Measuring angle ^[5]		±30°	±24°	±17°
Numerical aperture (NA)		0.55	0.45	0.30
Min. target thickness		0.05 mm	0.15 mm	0.5 mm
Target material		Reflective, diffuse as well as transparent surfaces (e.g. glass)		
Supply voltage		24 VDC ±10 %		
Power consumption		< 7 W (24V)		
Signal input		2x encoders (A+, A-, B+, B-, index); 3x encoders (A+, A-, B+, B-) 2x HTL/TTL multi-function inputs: trigger in, slave in, zero setting, mastering, teach-in; 1x RS422 synchronization input: trigger in, sync in, master/slave, master/slave alternating		
Digital interface ^[6]		EtherCAT / PROFINET / EtherNet/IP / RS422		
Analog output		4 ... 20 mA / 0 ... 5 V / 0 ... 10 V (16 bit D/A converter)		
Switching output		Error1-Out, Error2-Out		
Digital output		Sync out		
Connection		12-pin M12 connector for supply, encoder, EtherCAT, PROFINET, EtherNet/IP, RS422 and Sync 17-pin M12 connector for I/O analog and encoder optional extension to 3 m / 6 m / 9 m / 15 m possible (see accessories for suitable connection cables)		
Mounting		Radial clamping (see accessories for mounting adapter), threaded holes		
Temperature range	Storage	-20 ... +70 °C		
	Operation	+5 ... +50 °C		
Shock (DIN EN 60068-2-27)		15 g / 6 ms on XY axis, 1000 shocks each		
Vibration (DIN EN 60068-2-6)		2 g / 20 ... 500 Hz in XY axis, 10 cycles each		
Protection class (DIN EN 60529)	Sensor	IP64 (front)		
	Controller	IP65		
Material		Aluminum housing, passive cooling		
Weight		approx. 500 g	approx. 600 g	approx. 800 g
Control and indicator elements		Correct button: interface selection, two adjustable functions and reset to factory setting after 10 s; 4x color LEDs for Intensity, Range, Data connections (2x)		

^[1] All data at constant ambient temperature (24 ±2 °C). Average from 2,048 values at 1 kHz, in the mid of the measuring range onto optical flat

^[2] RMS noise relates to mid of measuring range (1 kHz)

^[3] Maximum deviation from reference system over the entire measuring range, measured on front surface of ND filter

^[4] In the mid of the measuring range

^[5] Maximum sensor tilt angle that produces a usable signal on polished glass (n = 1.5) in the mid of the measuring range. The accuracy decreases when approaching the limit values.

^[6] The controller can also be parameterized via Ethernet

High performance sensor system with integrated controller

confocalDT IFD2415

Model		IFD2415-1 Ethernet	IFD2415-3 Ethernet	IFD2415-10 Ethernet
Measuring range		1 mm	3 mm	10 mm
Start of measuring range		approx. 10 mm	approx. 20 mm	approx. 50 mm
Resolution	Static ^[1]	< 4 nm	< 8 nm	< 18 nm
	Dynamic ^[2]	< 38 nm	< 80 nm	< 204 nm
Measuring rate		Continuously adjustable from 100 Hz to 25 kHz		
Linearity ^[3]	Displacement and distance	< ±0.2 μm	< ±0.6 μm	< ±2 μm
	Thickness	< ±0.4 μm	< ±1.2 μm	< ±4 μm
Multi-peak measurement		5 layers		
Light source		Internal white LED		
Permissible ambient light		30.000 lx		
Light spot diameter ^[4]		8 μm	9 μm	16 μm
Measuring angle ^[5]		±30°	±24°	±17°
Numerical aperture (NA)		0.55	0.45	0.30
Min. target thickness		0.05 mm	0.15 mm	0.5 mm
Target material		Reflective, diffuse as well as transparent surfaces (e.g. glass)		
Supply voltage		24 VDC ±10 %		
Power consumption		< 7 W (24V)		
Signal input		3 x encoders (A+, A-, B+, B-) 2 x HTL/TTL multifunction input: trigger in, slave in, zeroing, master, teach; 1 x RS422 synchronization input: trigger in, sync in, master/slave, master/slave alternating		
Digital interface		Ethernet / RS422		
Analog output		4 ... 20 mA / 0 ... 5 V / 0 ... 10 V (16 bit D/A converter)		
Switching output		Error1-Out, Error2-Out		
Digital output		Sync out		
Connection		12-pin M12 connector for supply, Ethernet, RS422 and Sync 17-pin M12 connector for I/O analog and encoder optional extension to 3 m / 6 m / 9 m / 15 m possible (see accessories for suitable connection cables)		
Mounting		Radial clamping (see accessories for mounting adapter), threaded holes		
Temperature range	Storage	-20 ... +70 °C		
	Operation	+5 ... +50 °C		
Shock (DIN EN 60068-2-27)		15 g / 6 ms in XY axis, 1000 shocks each		
Vibration (DIN EN 60068-2-6)		2 g / 20 ... 500 Hz in XY axis, 10 cycles each		
Protection class (DIN EN 60529)	Sensor	IP64 (front)		
	Controller	IP65		
Material		Aluminum housing, passive cooling		
Weight		approx. 500 g	approx. 600 g	approx. 800 g
Control and indicator elements		Correct button, LEDs for Intensity, Range, Link and Data		

^[1] All data at constant ambient temperature (24 ±2 °C). Average from 2,048 values at 1 kHz, in the mid of the measuring range onto optical flat

^[2] RMS noise relates to mid of measuring range (1 kHz)

^[3] Maximum deviation from reference system over the entire measuring range, measured on front surface of ND filter

^[4] In the mid of the measuring range

^[5] Maximum sensor tilt angle that produces a usable signal on polished glass (n = 1.5) in the mid of the measuring range. The accuracy decreases when approaching the limit values.

Dimensions

(in mm, not to scale)

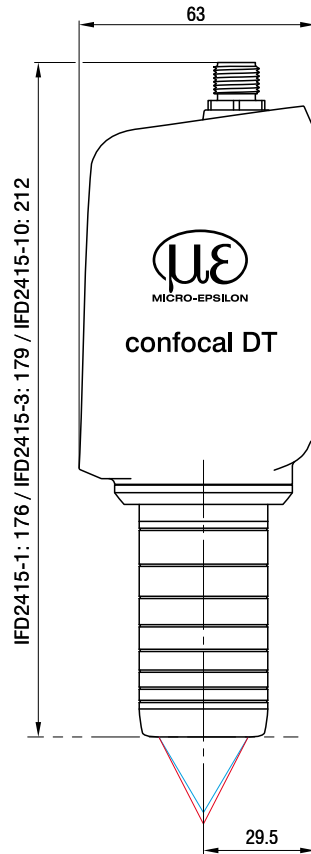

IFD2415-1/IE
IFD2415-1 Ethernet

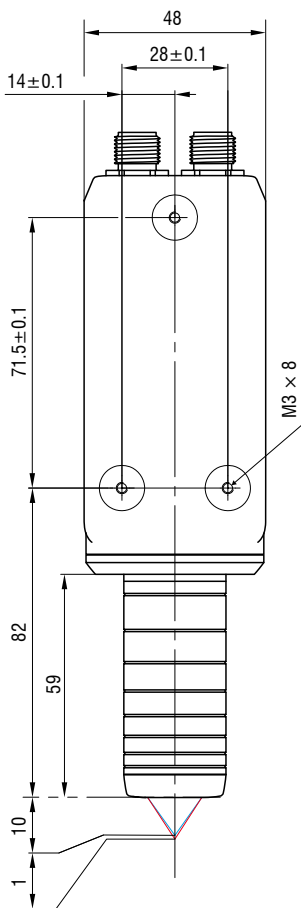

IFD2415-3/IE
IFD2415-3 Ethernet

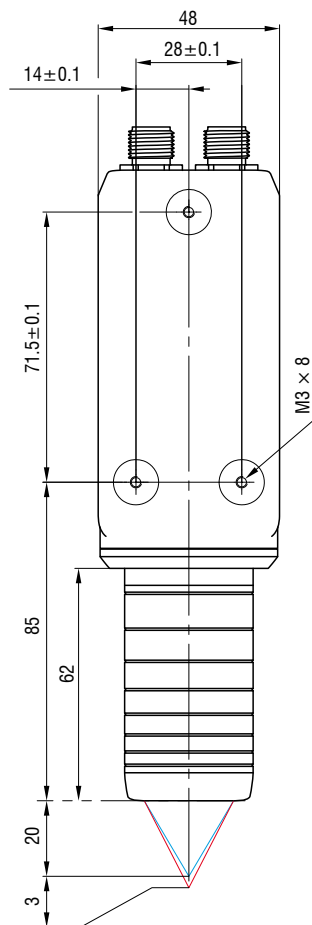

IFD2415-6/IE
IFD2415-6 Ethernet

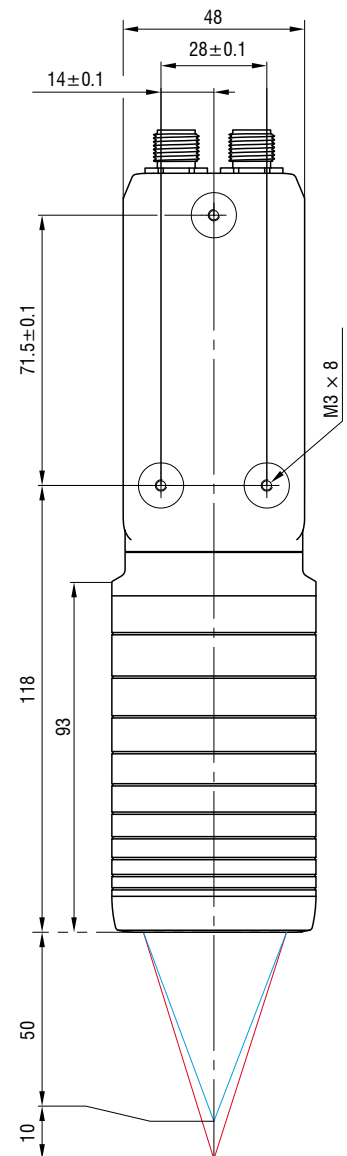

Connection possibilities confocalDT

IFD2410 / IFD2415



* Can be connected via the PS2020 power supply unit (24 V / 2.5 A)

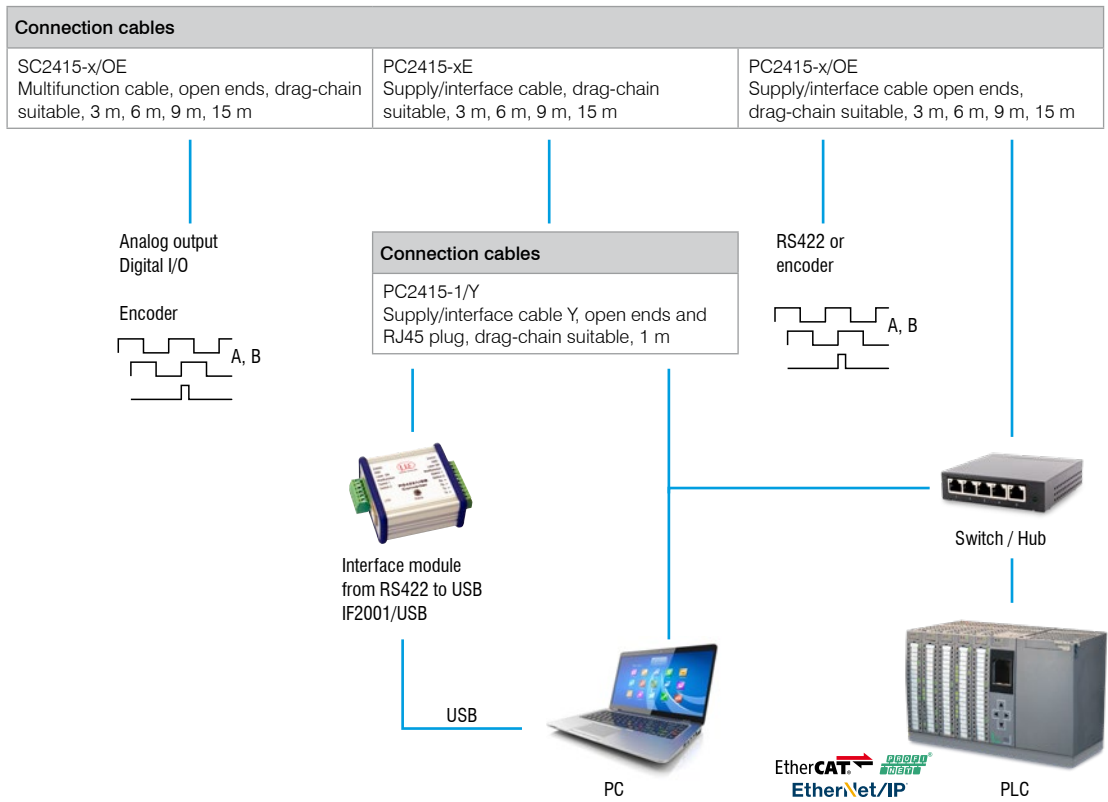

IFC2411 / IFC2416 IFC2412 / IFC2417



* Can be connected via the PS2020 power supply unit (24 V / 2.5 A)

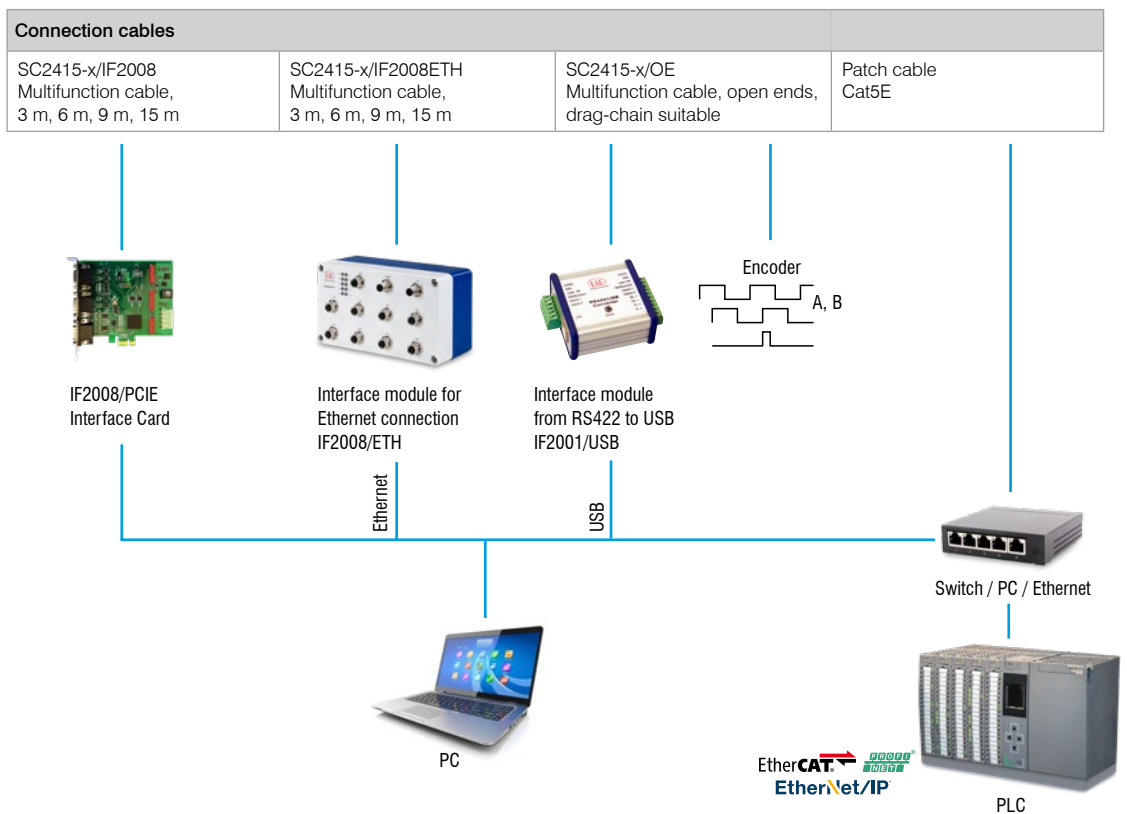

Accessories

Interface modules

Module	IFD2410/IFD2415	IFC2411/12	IFC2416/17	IFC242x	IFC246x
IF2001/USB Single-channel RS422/USB converter cable	✓	✓	✓	✓	✓
IF2004/USB RS422/USB converter to convert up to 4 digital signals to USB	⊘	✓	✓	✓	✓
IF2008/ETH Interface module for Ethernet connection for up to 8 sensors	⊘	✓	✓	✓	✓
IF2008PCIE Interface card for multiple sensor signals; analog and digital interfaces	⊘	✓	✓	✓	✓
IF2035/PNET Interface module for Industrial Ethernet connection (PROFINET)	⊘	⊘	⊘	✓	✓
IF2035/ENETIP Interface module for Industrial Ethernet connection (EtherNet/IP)	⊘	⊘	⊘	✓	✓

IF2001/USB converter RS422 to USB

The RS422/USB converter converts the digital signals of a confocal controller into a USB data packet. The sensor and the converter are connected via the RS422 interface of the converter. Data output is via the USB interface. The converter also passes through additional signals and functions such as laser on/off, switch signals and function output. The connected controllers and the converter can be programmed through software.

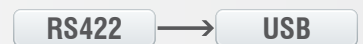
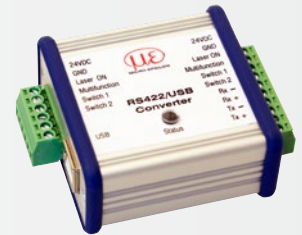

Characteristics

- Robust aluminum housing
- Easy sensor connection via screw terminals (plug and play)
- Conversion from RS422 to USB
- Supports baud rates from 9.6 kBaud to 12 MBaud

IF2004/USB: 4-channel converter from RS422 to USB

The RS422/USB converter is used for transforming digital signals of up to four confocal controllers into USB data signals. The converter has four trigger inputs and a trigger output for connecting additional converters. Data is output via a USB interface. The connected controllers and the converter can be programmed through software. The COM interfaces can be used individually and can be switched.

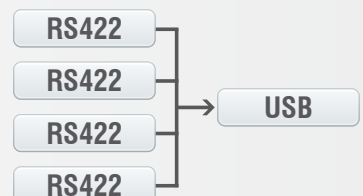

Characteristics

- 4x digital signals via RS422
- 4x trigger inputs, 1x trigger output
- Synchronous data acquisition
- Data output via USB

Sensors and Systems from Micro-Epsilon



Sensors and systems for displacement, distance and position



Sensors and measurement devices for non-contact temperature measurement



Measuring and inspection systems for metal strips, plastics and rubber



Optical micrometers and fiber optics, measuring and test amplifiers



Color recognition sensors, LED analyzers and inline color spectrometers

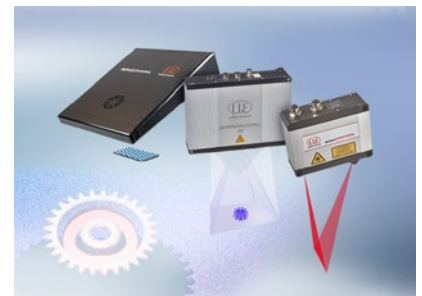

3D measurement technology for dimensional testing and surface inspection